



DLC Carbide End Mills for Non-ferrous Materials

AE-N SERIES

AE-TS-N · AE-TL-N · AE-VTS-N · AE-VTFE-N · AE-LNBD-N · AE-CPR-N · PXAL

Volume 5.1

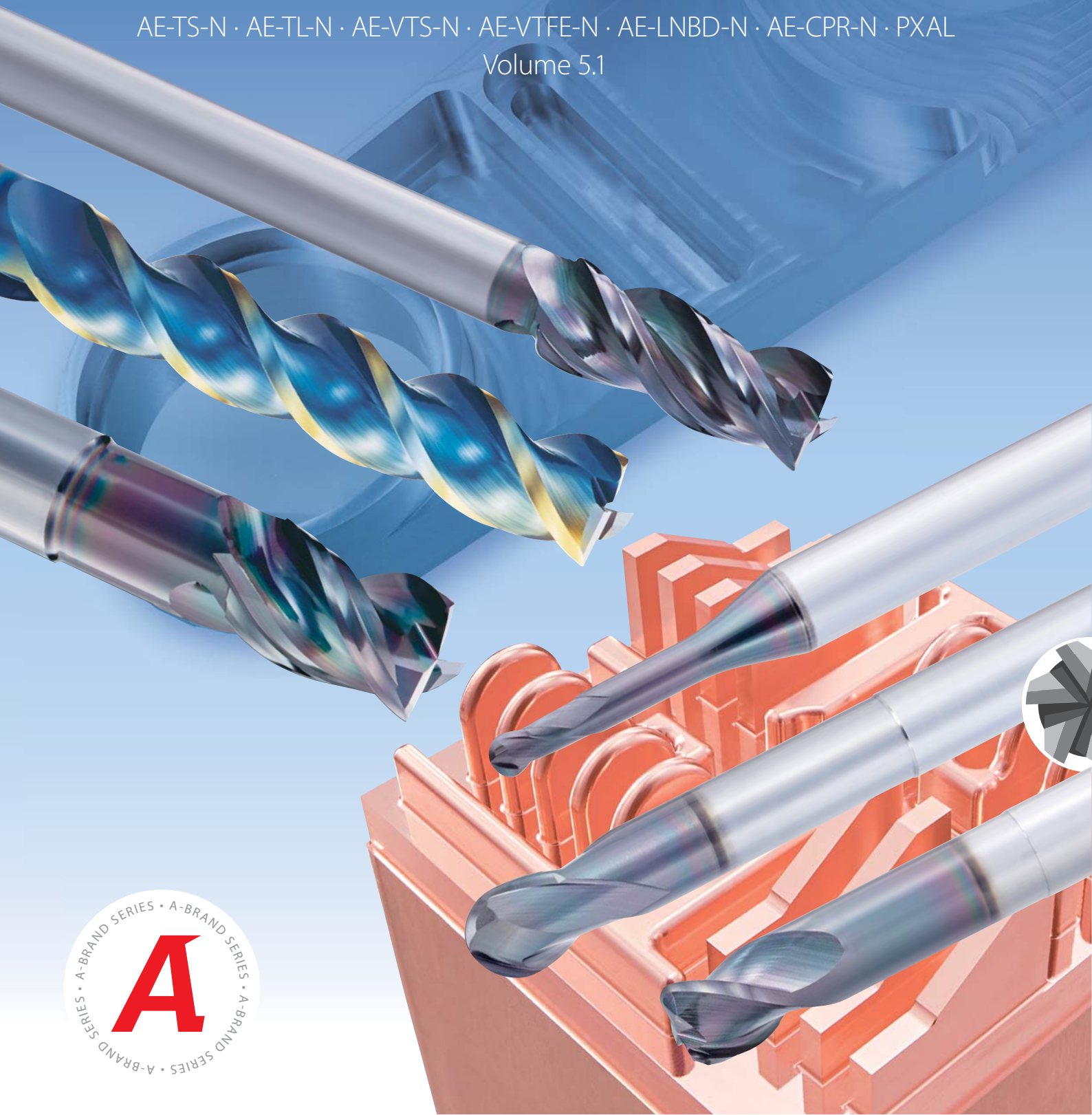

INDEX



AE-TS-N Short

- 1,5xD cutting length (Neck length 3 x D)
- Ø 1 ~ Ø 25
- DLC-Super Hard Coating

Features PAGE 8

Dimensions square & CR typePAGE 12

Dimensions SPPAGE 13
(sharp corner edge type)

Cutting conditions PAGE 16-17



AE-TL-N Long

- 3xD & 5xD cutting length
- Ø 3 ~ Ø 25
- DLC-Super Hard Coating

FeaturesPAGE 8

Dimensions squarePAGE 14

Dimensions SPPAGE 15
(sharp corner edge type)

Cutting conditions PAGE 18-19



AE-VTS-N Short (High performance type)

- 1,5xD cutting length (Neck length 3xD)
- Ø 1 ~ Ø 12
- DLC-IGUSS Coating

Features PAGE 20

Dimensions square & CR typePAGE 23

Dimensions SPPAGE 24

Cutting conditions PAGE 25-26
(sharp corner edge type)



AE-VTFE-N (Deep side milling)

- 2,5xD cutting length (reduced shank)
- Ø 6 ~ Ø 22
- DLC-IGUSS Coating

FeaturesPAGE 28

DimensionsPAGE 32

Cutting conditions PAGE 33

Milling | Solid carbide



AE-LNBD-N

- 2 flute long neck ball type
- R0,05 - R3
- DLC-IGUSS Coating

Features PAGE 34

Dimensions PAGE 39

Cutting conditions PAGE 41



PXAL (Exchangeable head end mill)

- 1xD cutting length
- Ø 10 ~ Ø 25
- DLC-IGUSS Coating

FeaturesPAGE 52

Dimensions headsPAGE 55

Dimensions PXMZ holdersPAGE 56

Cutting conditions PAGE 57-58

PXMC collet & holder PAGE 59~



AE-CPR-N NEW









- 2-3 flute specification
- D0,2 - D6
- DLC-IGUSS Coating

Features PAGE 42

DimensionsPAGE 46

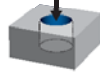
Cutting conditions PAGE 50

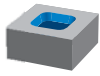
APPLICATION

Application				Slot Milling	Trochoidal Milling	Side Milling	Deep Side Milling	Plunging	Helical Milling	Contour Milling	Ramping
											
Standard	AE-TS-N Short	1.5 × D cutting length	Square Sharp Corner Edge Radius	○	☆	☆	○	○	○	○	○
	AE-TL-N Long	3 × D cutting length	Square Sharp Corner Edge	○	☆	○	○	○	○	○	○
		5 × D cutting length	Square Sharp Corner Edge	△	☆	○	○	△	○	△	△
High Performance	AE-VTS-N Short	1.5 × D cutting length	Square Sharp Corner Edge Radius	☆	☆	☆	☆	☆	☆	☆	☆
	AE-VTFE-N Deep side milling	2.5 × D cutting length	Square Radius	△	○	○	☆	△	○	△	△
	PXAL Exchangeable Head	1 × D cutting length	Square Radius	☆	☆	☆	☆	☆	☆	☆	☆

△ → ○ → ◎ → ☆
(Fair) (Best)

DLC coated end mills for deep side milling in non-ferrous metals

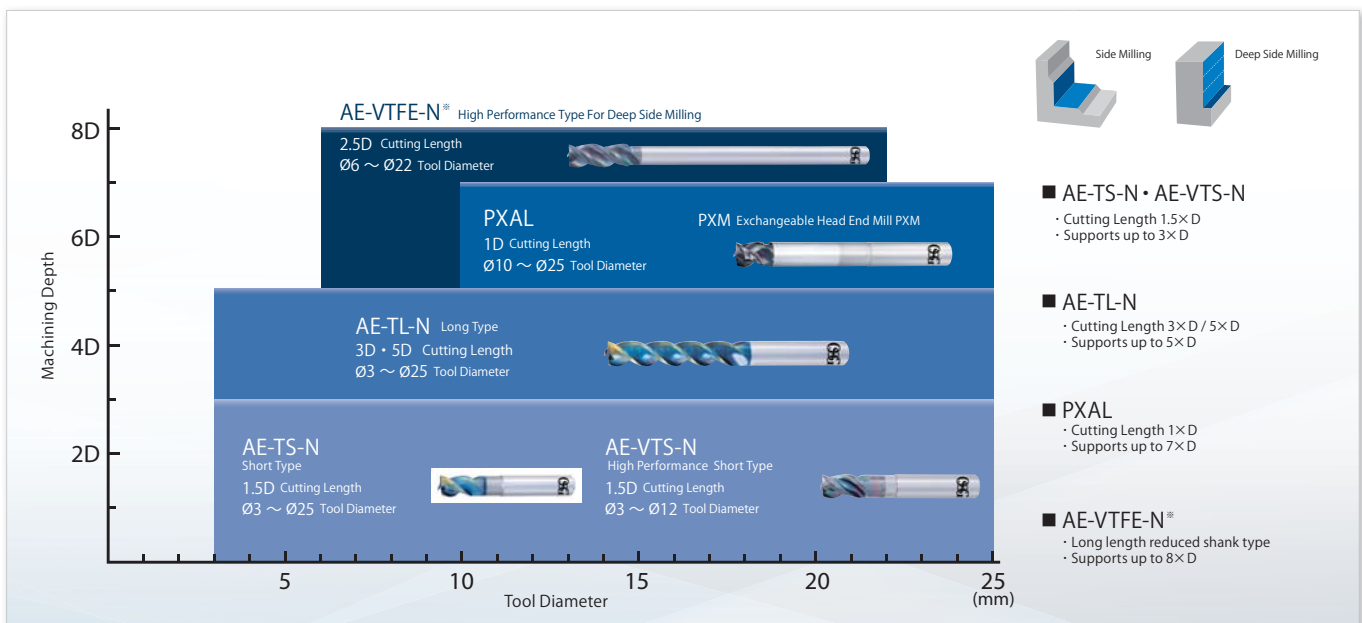

*Please use the Ø22 AE-VTFE-N at L/D = 7 or less.



FEATURES OF DLC COATING

DLC coating revolutionizes the processing of non-ferrous materials!

OSG's DLC coating gives a shiny surface! This shiny and smooth surface optimizes end mill performance particularly in non-ferrous materials such as aluminum alloys, which require welding resistance and lubricity.

Two types of DLC coatings to accommodate specific application needs

DLC-IGUSS

- Thick coating type for long tool life
- Thick coating type suppresses wear on the cutting edge to enable high durability and long tool life.
- Applicable tools : AE-VTS-N • AE-VTFE-N • PXAL

DLC-SUPER HARD

- Thin coating type with emphasis on sharpness
- High adhesion to the base material to enable sharp cutting performance and high welding resistance.
- Applicable tools : AE-TS-N • AE-TL-N • AE-VTFE-N

Name of Coating	Coating Color	Coating Type	(GPa) Hardness	Oxidation Temperature (C°)	Coefficient of Friction	(µm) Coating Thickness	Coating Temperature (C°)	Surface roughness	Wear Resistance	Welding Resistance	Toughness
DLC-IGUSS	Interference Color	DLC(SP ² Rich)	60	550	0.10	0.8	400	☆	◎	☆	○
DLC-SUPER HARD	Interference Color	DLC(SP ² Rich)	60	550	0.10	0.2	400	☆	◎	☆	○

(Good) ○ → ◎ → ☆ (Best)

Abrasion resistance and welding resistance

OSG's DLC coating has high wear resistance and anti-adhesion properties, which enable stable tool life in non-ferrous material applications with high tendency to weld.

Wear resistance

Milling in A5052

Tool	Carbide Square End Mill 3 Flutes
Work Material	A5052
Cutting Speed	200m/min (6.370 min ⁻¹)
Feed	0,08mm/t (1.530mm/min)
Depth of Cut	ap = 5mm ae = 8mm
Coolant	AirBlow
Machine	Vertical Machining Center
Milling Length	50m

Welding resistance

Surface condition after pin-on-disc test

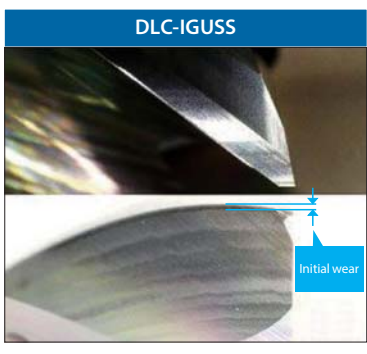
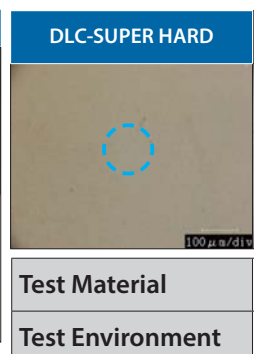
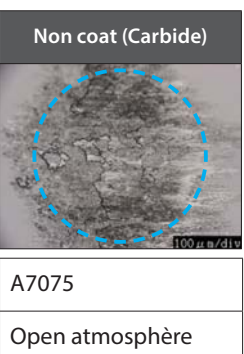
DLC-IGUSS	DLC-SUPER HARD	Non coat (Carbide)
		
Test Material	A7075	
Test Environment	Open atmosphere	

CUTTING DATA ON ALUMINUM PART PROCESSING

Suitable for a wide range of applications

Coolant	MQL	Holder	Shrink Fit	Machine	5 axis Machining center
Max. RPM	25.000 min ⁻¹	Work Material	A5052	Main Spindle	HSK63



Process	Milling Part	Milling Method	Milling Process	Tool
①	Top	Face Milling	Roughing	PXAL 250C25-03R100
②	Overall	Contour Milling	Roughing	PXAL 200C20-03R100
③	Top	Face Milling	Finishing	AE-TS- N Ø12x36
④	Boss, Hole Side	Side Milling	Finishing	
⑤	Hole Top	Face Milling	Finishing	AE-VTS- N Ø12x36
⑥	Counterbore Wall	Side Milling	Finishing	
⑦	Groove	Pocket Milling	Roughing	AE-VTS- N Ø10x30
			Finishing	
⑧	Bottom	Pocket Milling	Roughing	AE-VTS- N Ø10x30
			Finishing	
⑨	Slot	Slot Milling 5-axis	Finishing	AE-TS- N Ø10x30
⑩	Outer circumference, lower counterbore	Side Milling	Finishing	AE-TL- N Ø8x40

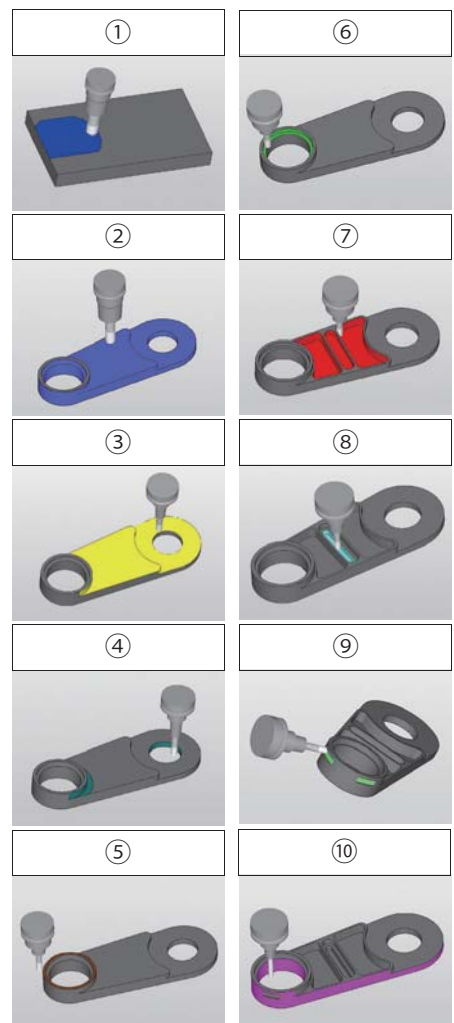

Milling | Solid carbide



CUTTING DATA ON ALUMINUM PART PROCESSING

High efficiency and high quality deep side milling and pocket milling

Part Name	Vacuum Chamber
Work Material	A5056
Machine	5 axis Machining center
Main Spindle	HSK-A63
Coolant	MQL

However, water-soluble coolant is used for threading and drilling

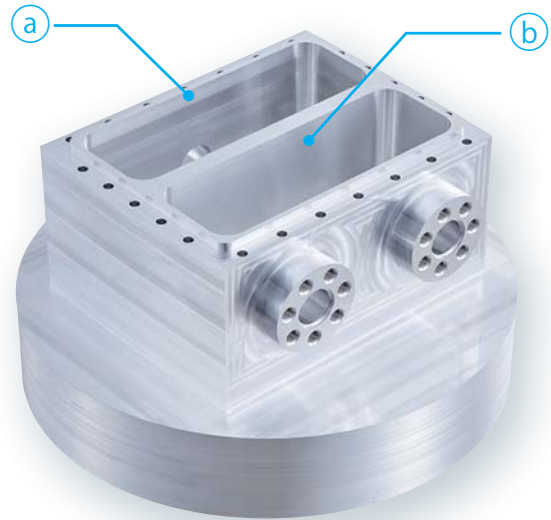

Process	Processing Location	Milling Process	Tool
①	Top and Side	Roughing·Finishing	PFAL04R100M25.4-8 Ø100
②	Side Convex Part	Roughing·Finishing	AE-VTFE-N Ø12 (L/D=5.5 66mm)
③	Side	Roughing·Finishing	AE-VTFE-N Ø12 (L/D=8 96mm)
④	a、b Pocket	Roughing	AE-TS-N Ø20×60
		Bottom Finishing	
⑤	a Pocket	Semi-finishing·Finishing	AE-VTFE-N Ø12 (L/D=5.5 66mm)
⑥	b Pocket	Semi-finishing·Finishing	AE-TL-N Ø12×60
⑦	Side Convex Part	Helical Milling	AE-VTFE-N Ø12 (L/D=5.5 66mm)
		Counterboring	
		Chamfering	PLDS11R002SS16-90 Ø14.4×90°
		M8×1,25 Threading	AT-2 R-SPEC M8×1.25 6.2×16 P1.25 INT
⑧	Seal Surface	Roughing·Finishing	AE-VTS-N Ø10×30
		Drilling	NF-GDN Ø5

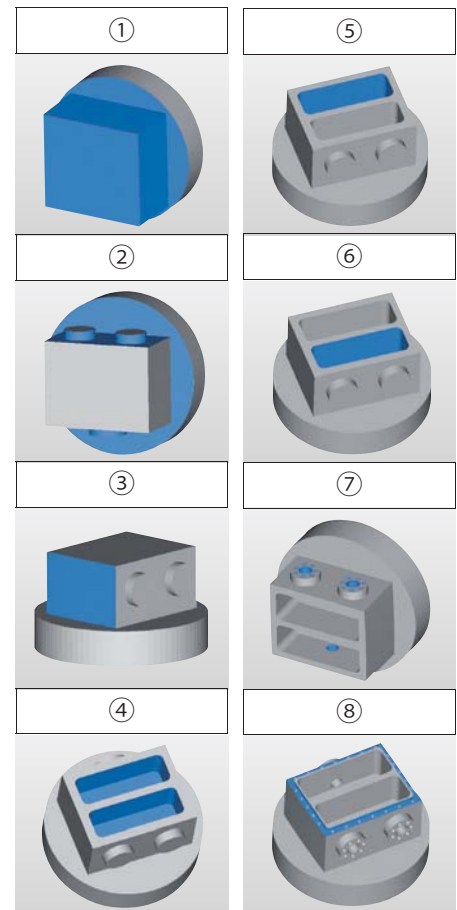

Milling | Solid carbide



CUTTING DATA ON ALUMINUM PART PROCESSING

Optimum tooling for highly efficient machining

High-efficiency machining in which 4 processes are completed in a total of 8 minutes and 30 seconds

Part Name	Inverter Case
Work Material	AC4C
Machine	SPEEDIO series
Main Spindle	BT30
Coolant	Water-Soluble

Cooperation : BROTHER INDUSTRIES, LTD.

SPEEDIO

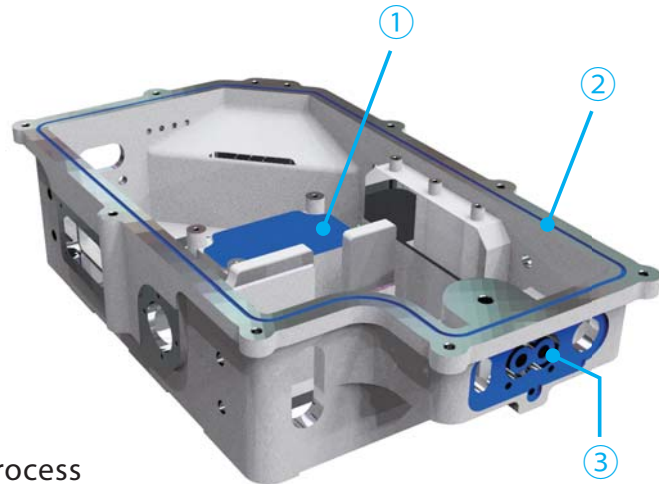

Introduction of a part of the machining process

Processing Location	Tool	Process	Depth of Cut		Milling Condition	
			ap (mm)	ae (mm)	Cutting Speed (m/min)	Feed (mm/min)
①	Head: PXAL200C20-03R000 Ø20 Holder: PXMZ-C200SS20-S120	Face Milling	4	18	500 (8.000min ⁻¹)	4.000 (0.167mm/t)
②	AE-TS-N Ø3×9	Slot Milling	1	3	150 (16.000min ⁻¹)	2.000 (0.042mm/t)
③	AE-VTS-N Ø10×30	Slot Milling	1,5	10	410 (13.000min ⁻¹)	3.820 (0.098mm/t)

List of tools used

Main Machining	Tool
Mating Surface	PFAL04R063M22-8 Ø63
Face Milling	Head: PXAL200C20-03R000 Ø20 Holder: PXMZ-C200SS20-S120
Contour Milling	Head: PXAL200C20-03R000 Ø20 Holder: PXMZ-C200SS20-S120
	AE-VTS-N Ø10×30
	AE-VML Ø12×48-N
Slot Milling	AE-TS-N Ø3×9
	AE-VTS-N Ø10×30

Main Machining	Tool
Drilling	ADO-SUS-3D Ø2.8
	ADO-SUS-3D Ø3.5
	ADO-SUS-3D Ø4.2
	ADO-SUS-3D Ø7.9
Flat Surface Drilling	P2D3000BT30M09 Ø30 Special
	ADF-2D Ø13
Chamfering	AD-LDS Ø8×90°

Main Machining	Tool
Threading	A-SFT M4×0.5
	A-SFT M5×0.8
	S-XPFF M3×0.5
	AT-2 R-SPEC M8×1.25 6.2×16 P1.25-INT
Hole Finishing	CRM Ø8

Milling | Solid carbide

Enables dramatic reduction in machining time!

High-efficiency thread mill with end-cutting edge for non-ferrous metals

AT-2 R-SPEC

A
The A Brand

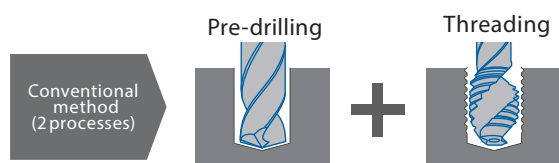

Useful for preventing shifting of cutting position in cast hole

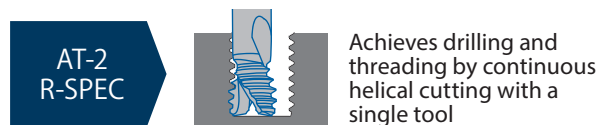

KEY FEATURES: AE-TS-N • AE-TL-N

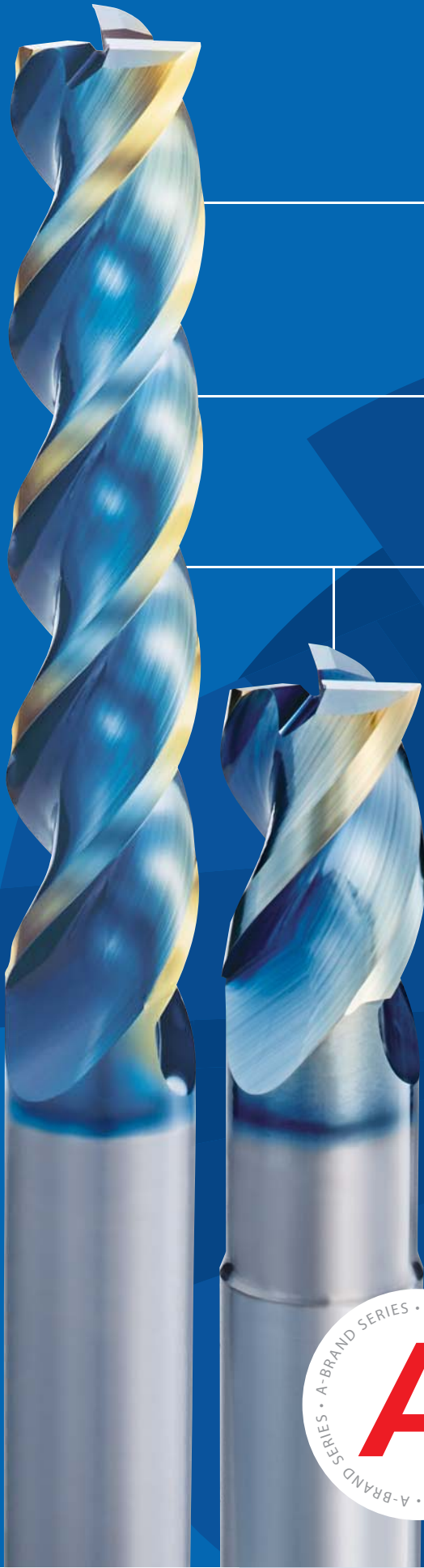

- 1** Cutting edge specification that achieves both rigidity and sharpness. Achieves high durability and good surface finish
- 2** New flute form. Facilitates excellent chip evacuation.
- 3** DLC-SUPER HARD Coating

Due to the smoothness of the coating surface, it is extremely effective for non-ferrous materials such as aluminum alloys that require welding resistance and lubricity. Furthermore, its excellent sharpness and ability to suppress burrs enable superior surface finish.



STANDARD SPECIFICATION SUITABLE FOR NON-FERROUS MATERIAL PROCESSING

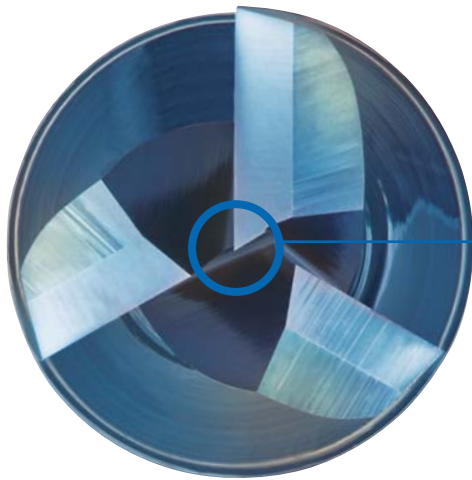

Large core design

High rigidity prevents chattering

Center cutting edge

Can be used for plunging

Balancing rigidity and chip evacuation capability

Rigidity is enhanced by increasing the core thickness, which enables the suppression of chattering. By adopting an optimal flute form, high rigidity can be maintained while ensuring trouble-free chip evacuation.

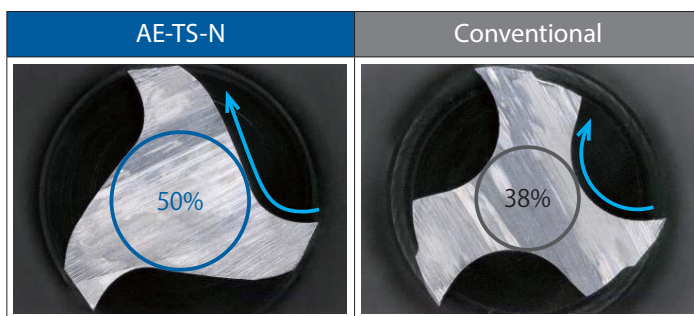

Arrow: indicates chip discharge direction

CUTTING DATA

High Quality

High welding resistance

By adopting the DLC coating, high welding resistance is achieved even with air blow.

Tool	AE-TS-N φ10×30	Non-coated Competitor φ10 3 Flutes
Work Material	A7075	
Milling Method	Slot Milling	
Cutting Speed	300m/min (9,550min ⁻¹)	
Feed	1,432mm/min(0.05mm/t)	
Depth of Cut	ap =10mm	
Coolant	AirBlow	
Machine	Vertical Machining Center	

Cutting edge condition after milling 11 m

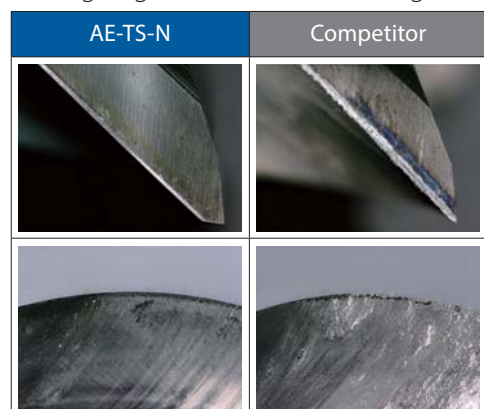

CUTTING DATA

High precision, Good machined surface quality

Effects by the combination of DLC coating and unique cutting edge specification for non-ferrous metal machining

Achieves good machined surface quality.

Tool	AE-TS-N Ø20 Square	Conventional
Work Material	A7075	
Milling Method	Side Step Milling	
Cutting Speed	300m/min (4.750 min ⁻¹)	
Feed	700mm/min (0,05 mm/t)*	
Depth of Cut	ap = 20mm X 2 Times ae = 6mm	
Coolant	Water Soluble	
Machine	Horizontal Machining Center (BT50)	

*Machined at a reduced feed rate for the cutting trial.

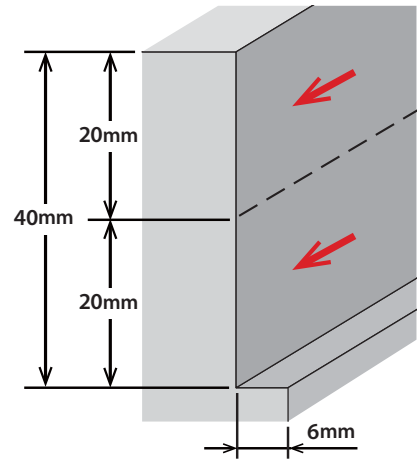

Good machined surface

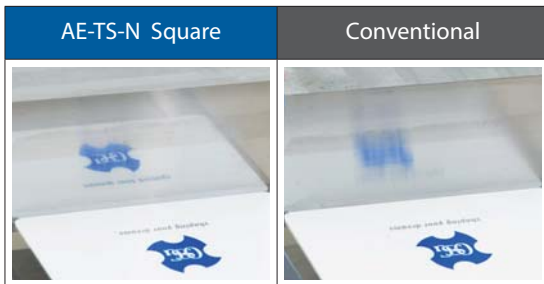

Side roughness at the initial stage of machining

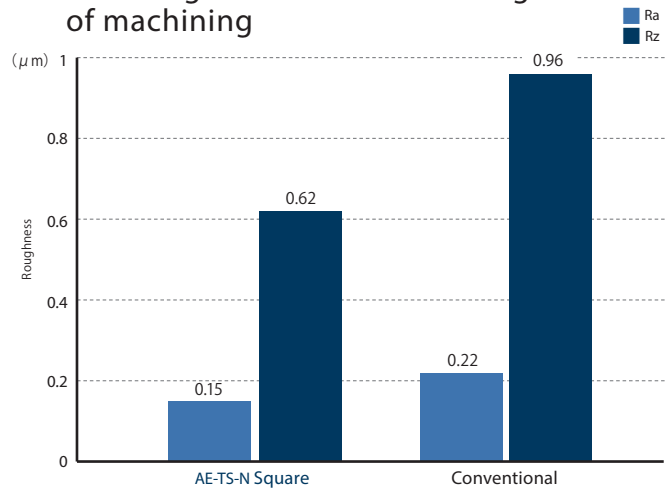

Effects of the radius type

The radius type is effective in improving the machined surface quality of the bottom surface.

Tool	AE-TS-N Ø6 x 18 x R0,5 Radius	AE-TS-N Ø6 x 18 Square
Work Material	A7075	
Milling Method	Slot Milling	
Cutting Speed	Vc=350m/min (18.568 min ⁻¹)	
Feed	Vf=2.785mm/min (0,05 mm/t)	
Depth of Cut	ap = 6mm (1D)	
Coolant	Water Soluble	
Machine	Vertical Machining Center (BT40)	

Bottom roughness at the initial stage of machining

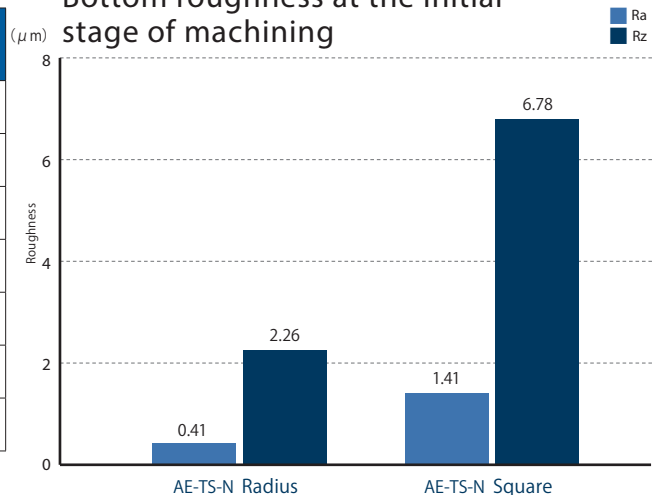

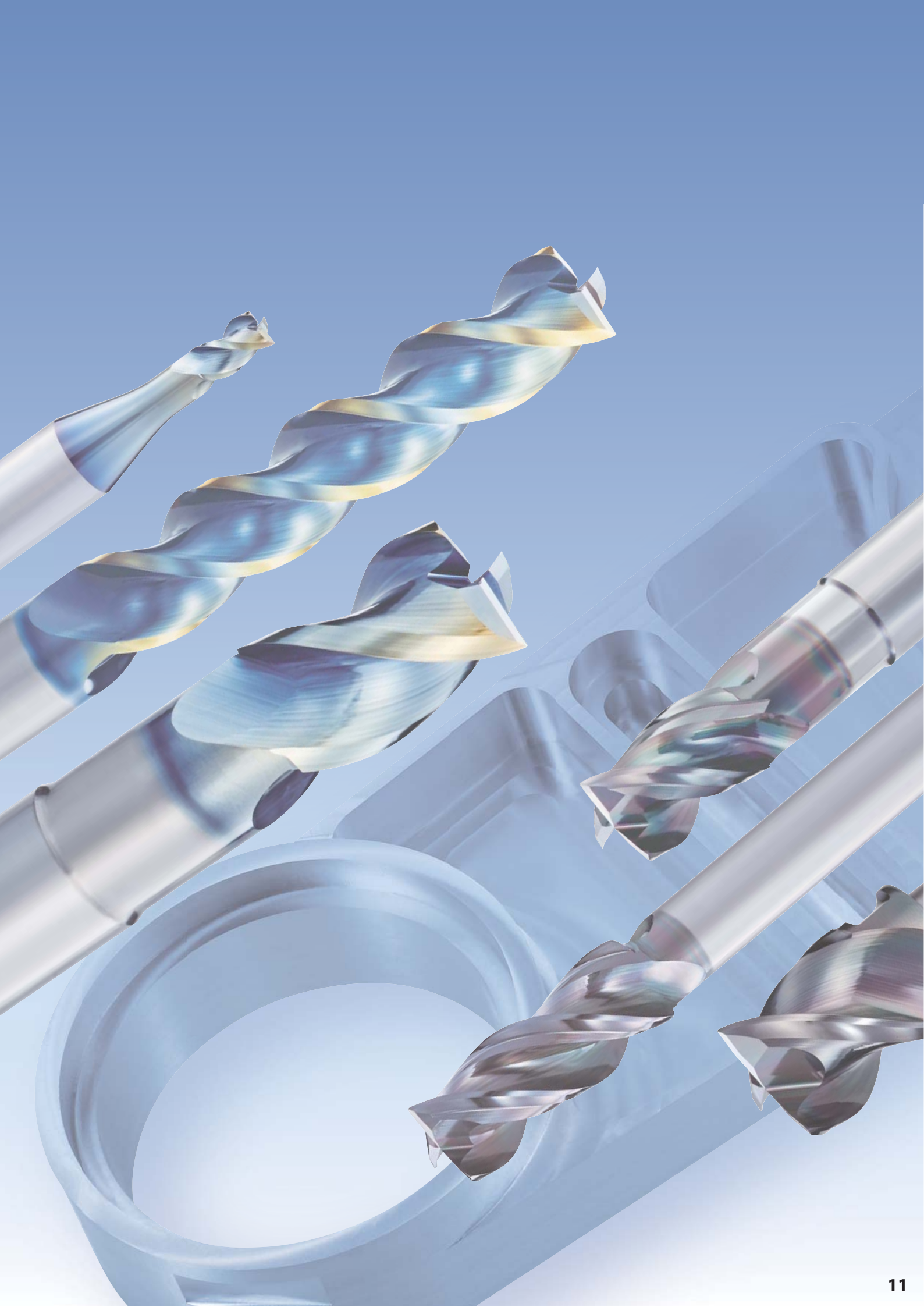

AE-TS-N

Milling | Solid carbide

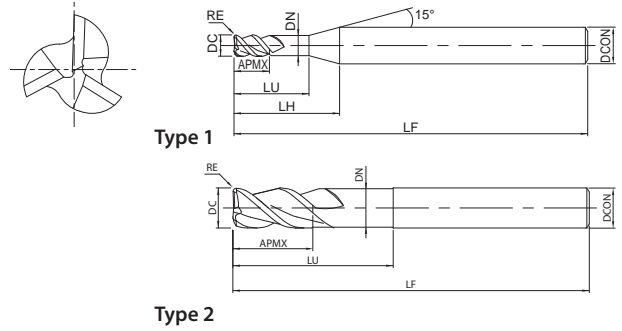

- First choice in quality and performance
- Carbide end mill with DLC coating
- For non-ferrous materials
- 3 flutes, short length of cut



Milling | Solid carbide

EDP	ZEFP	DC	RE	LU	LF	APMX	LH	DCON	DN	Type
8557235	3	1	-	3	45	1,5	8,6	4	0,95	1
8557236	3	1,5	-	4,5	45	2,3	9,3	4	1,45	1
8557237	3	2	-	6	45	3	10,1	4	1,9	1
8557238	3	2,5	-	7,5	45	3,8	10,6	4	2,4	1
8557330	3	3	-	9	55	4,5	14,9	6	2,85	1
8557370	3	3	0,2	9	55	4,5	14,8	6	2,85	1
8557371	3	3	0,5	9	55	4,5	14,8	6	2,85	1
8557331	3	4	-	12	55	6	16	6	3,8	1
8557372	3	4	0,2	12	55	6	15,9	6	3,8	1
8557373	3	4	0,5	12	55	6	15,9	6	3,8	1
8557374	3	4	1	12	55	6	15,9	6	3,8	1
8557332	3	5	-	15	55	7,5	17,1	6	4,8	1
8557375	3	5	0,2	15	55	7,5	16,8	6	4,8	1
8557376	3	5	0,5	15	55	7,5	16,8	6	4,8	1
8557377	3	5	1	15	55	7,5	16,8	6	4,8	1
8557333	3	6	-	18	60	9	-	6	5,8	2
8557378	3	6	0,3	18	60	9	-	6	5,8	2
8557379	3	6	0,5	18	60	9	-	6	5,8	2
8557380	3	6	1	18	60	9	-	6	5,8	2
8557334	3	8	-	24	70	12	-	8	7,7	2
8557381	3	8	0,3	24	70	12	-	8	7,7	2
8557382	3	8	0,5	24	70	12	-	8	7,7	2
8557383	3	8	1	24	70	12	-	8	7,7	2
8557384	3	8	1,5	24	70	12	-	8	7,7	2
8557385	3	8	2	24	70	12	-	8	7,7	2
8557335	3	10	-	30	75	15	-	10	9,7	2
8557386	3	10	0,3	30	75	15	-	10	9,7	2
8557387	3	10	0,5	30	75	15	-	10	9,7	2
8557388	3	10	1	30	75	15	-	10	9,7	2
8557389	3	10	1,5	30	75	15	-	10	9,7	2
8557390	3	10	2	30	75	15	-	10	9,7	2
8557391	3	10	3	30	75	15	-	10	9,7	2
8557336	3	12	-	36	80	18	-	12	11,7	2
8557392	3	12	0,3	36	80	18	-	12	11,7	2
8557393	3	12	0,5	36	80	18	-	12	11,7	2
8557394	3	12	1	36	80	18	-	12	11,7	2
8557395	3	12	1,5	36	80	18	-	12	11,7	2
8557396	3	12	2	36	80	18	-	12	11,7	2
8557397	3	12	3	36	80	18	-	12	11,7	2
8557337	3	16	-	48	110	24	-	16	15,7	2
8557338	3	20	-	60	120	30	-	20	19,7	2
8557339	3	25	-	75	140	37,5	-	25	24,7	2

AE-TS-N SP

Milling | Solid carbide

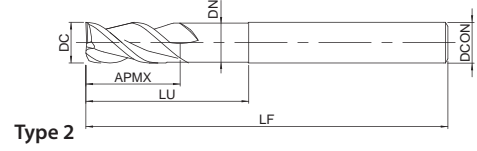
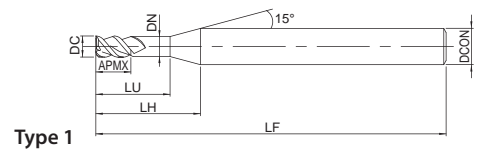
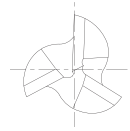

- First choice in quality and performance
- Carbide end mill with DLC coating
- For non-ferrous materials
- 3 flutes, short length of cut
- Sharp corner for milling 90° corner



EDP	ZEFP	DC	LU	LF	APMX	LH	DCON	DN	Type
8557239	3	1	3	45	1,5	8,6	4	0,95	1
8557240	3	1,5	4,5	45	2,3	9,3	4	1,45	1
8557241	3	2	6	45	3	10,1	4	1,9	1
8557242	3	2,5	7,5	45	3,8	10,6	4	2,4	1
8557430	3	3	9	55	4,5	14,8	6	2,85	1
8557431	3	4	12	55	6	15,9	6	3,8	1
8557432	3	5	15	55	7,5	16,8	6	4,8	1
8557433	3	6	18	60	9	-	6	5,8	2
8557434	3	8	24	70	12	-	8	7,7	2
8557435	3	10	30	75	15	-	10	9,7	2
8557436	3	12	36	80	18	-	12	11,7	2

Milling | Solid carbide

Sharp corner edge type for milling straight corners

The sharp corner edge type is designed without a gash land cutting edge specification, enabling it to mill straight corners.

Effective corner milling with no uncut residue left behind.



Sharp Corner Edge (SP)



Square Type

AE-TL-N

Milling | Solid carbide

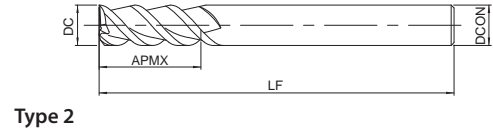
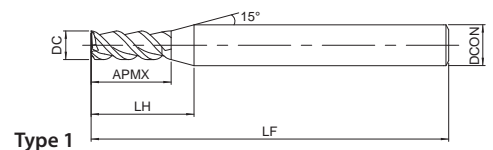
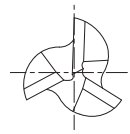

- First choice in quality and performance
- Carbide end mill with DLC coating
- For non-ferrous materials
- 3 flutes, long length of cut



Milling | Solid carbide

EDP	ZEFP	DC	LF	APMX	LH	DCON	ULDR	Type
8557340	3	3	55	9	17	6	3	1
8557350	3	3	55	15	23	6	5	1
8557341	3	4	55	12	18,1	6	3	1
8557351	3	4	60	20	26,1	6	5	1
8557342	3	5	55	15	19,3	6	3	1
8557352	3	5	65	25	29,3	6	5	1
8557343	3	6	60	18	-	6	3	2
8557353	3	6	75	30	-	6	5	2
8557344	3	8	70	24	-	8	3	2
8557354	3	8	90	40	-	8	5	2
8557345	3	10	75	30	-	10	3	2
8557355	3	10	100	50	-	10	5	2
8557346	3	12	80	36	-	12	3	2
8557356	3	12	110	60	-	12	5	2
8557347	3	16	120	48	-	16	3	2
8557357	3	16	150	80	-	16	5	2
8557348	3	20	135	60	-	20	3	2
8557358	3	20	175	100	-	20	5	2
8557349	3	25	155	75	-	25	3	2
8557359	3	25	205	125	-	25	5	2

AE-TL-N SP

Milling | Solid carbide

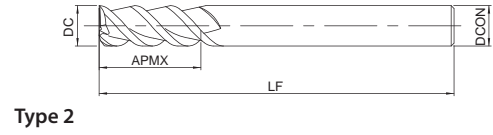
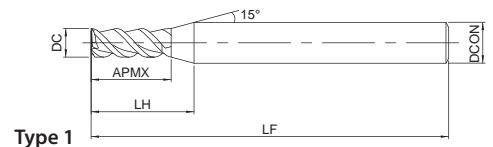
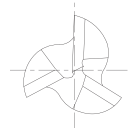

- First choice in quality and performance
- Carbide end mill with DLC coating
- For non-ferrous materials
- 3 flutes, long length of cut
- Sharp corner for milling 90° corner



EDP	ZEFP	DC	LF	APMX	LH	DCON	ULDR	Type
8557440	3	3	55	9	16,6	6	3	1
8557450	3	3	55	15	22,6	6	5	1
8557441	3	4	55	12	17,7	6	3	1
8557451	3	4	60	20	25,7	6	5	1
8557442	3	5	55	15	18,9	6	3	1
8557452	3	5	65	25	28,9	6	5	1
8557443	3	6	60	18	-	6	3	2
8557453	3	6	75	30	-	6	5	2
8557444	3	8	70	24	-	8	3	2
8557454	3	8	90	40	-	8	5	2
8557445	3	10	75	30	-	10	3	2
8557455	3	10	100	50	-	10	5	2
8557446	3	12	80	36	-	12	3	2
8557456	3	12	110	60	-	12	5	2

Milling | Solid carbide

Sharp corner edge type for milling straight corners

The sharp corner edge type is designed without a gash land cutting edge specification, enabling it to mill straight corners.

Effective corner milling with no uncut residue left behind.

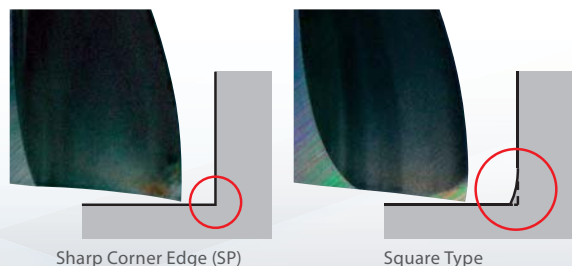

CUTTING CONDITIONS

Milling | Endmills | Cutting conditions

AE-TS-N Applies to square/sharp corner edge/radius type

Slot Milling

Vc (m/min)	Aluminum Alloy Expanding Material • Magnesium Alloy A5052 • A7075 • AZ91 • AZ80A		Aluminum Alloy Casting AC4C • ADC		Copper Alloy C1100	
	S (min ⁻¹)	F (mm/min)	S (min ⁻¹)	F (mm/min)	S (min ⁻¹)	F (mm/min)
300			300		150	
DC X LU	S (min ⁻¹)	F (mm/min)	S (min ⁻¹)	F (mm/min)	S (min ⁻¹)	F (mm/min)
1 x 3	32.000	1.200	32.000	1.200	16.000	540
1,5 x 4,5	32.000	1.350	32.000	1.350	16.000	610
2 x 6	32.000	1.540	32.000	1.540	16.000	660
2,5 x 7,5	32.000	1.630	32.000	1.630	16.000	810
3 x 9	32.000	1.720	32.000	1.720	16.000	960
4 x 12	24.000	1.780	24.000	1.780	12.000	1.030
5 x 15	19.200	1.840	19.200	1.840	9.600	1.090
6 x 18	16.000	1.900	16.000	1.900	8.000	1.160
8 x 24	12.000	2.030	12.000	2.030	6.000	1.300
10 x 30	9.600	2.150	9.600	2.150	4.800	1.430
12 x 36	8.000	2.270	8.000	2.270	4.000	1.560
16 x 48	6.000	2.380	6.000	2.380	3.000	1.630
20 x 60	4.800	2.490	4.800	2.490	2.400	1.700
25 x 75	3.850	2.600	3.850	2.600	1.900	1.780
Depth of cut	ap 1D			ap 0,5D		

1. The above milling condition is a guideline for the overhang length is 4xD.
 2. Use a rigid and precise machine and holder.
 3. The indicated speeds and feeds are for milling with water-soluble coolant.
 4. Please adjust the speed and feed when the cutting depth is large or when machines with low rigidity are used.
 5. Reduce speed and feed as well as depth of cut when high precision is required.
 6. Adjust the speed and feed accordingly when the overhang length is longer than specified (refer to p.10).
 7. Please always use the appropriate cutting fluid recommended by the cutting fluid manufacturer in the machining of magnesium alloys. Be cautious with the cutting chips as they are highly flammable and may pose a serious fire risk if not properly handled.

Side Milling

Vc (m/min)	Aluminum Alloy Expanding Material • Magnesium Alloy A5052 • A7075 • AZ91 • AZ80A		Aluminum Alloy Casting AC4C • ADC		Copper Alloy C1100	
	S (min ⁻¹)	F (mm/min)	S (min ⁻¹)	F (mm/min)	S (min ⁻¹)	F (mm/min)
300			300		150	
DC X LU	S (min ⁻¹)	F (mm/min)	S (min ⁻¹)	F (mm/min)	S (min ⁻¹)	F (mm/min)
1 x 3	32.000	1.300	32.000	1.300	16.000	600
1,5 x 4,5	32.000	1.430	32.000	1.430	16.000	660
2 x 6	32.000	1.730	32.000	1.730	16.000	720
2,5 x 7,5	32.000	1.920	32.000	1.920	16.000	900
3 x 9	32.000	2.150	32.000	2.150	16.000	1.200
4 x 12	24.000	2.230	24.000	2.230	12.000	1.290
5 x 15	19.200	2.300	19.200	2.300	9.600	1.360
6 x 18	16.000	2.380	16.000	2.380	8.000	1.450
8 x 24	12.000	2.540	12.000	2.540	6.000	1.620
10 x 30	9.600	2.690	9.600	2.690	4.800	1.780
12 x 36	8.000	2.840	8.000	2.840	4.000	1.950
16 x 48	6.000	2.980	6.000	2.980	3.000	2.040
20 x 60	4.800	3.100	4.800	3.100	2.400	2.130
25 x 75	3.850	3.200	3.850	3.200	1.900	2.200
Depth of cut	ap 1,5D		ae 0,2D			

1. The above milling condition is a guideline for the overhang length is 4xD.
 2. Use a rigid and precise machine and holder.
 3. The indicated speeds and feeds are for milling with water-soluble coolant.
 4. Please adjust the speed and feed when the cutting depth is large or when machines with low rigidity are used.
 5. Reduce speed and feed as well as depth of cut when high precision is required.
 6. Adjust the speed and feed accordingly when the overhang length is longer than specified (refer to p.10).
 7. Please always use the appropriate cutting fluid recommended by the cutting fluid manufacturer in the machining of magnesium alloys. Be cautious with the cutting chips as they are highly flammable and may pose a serious fire risk if not properly handled.

Milling | Solid carbide



CUTTING CONDITIONS

Milling | Endmills | Cutting conditions

AE-TS-N Applies to square/sharp corner edge/radius type

Plunging

	Aluminum Alloy Expanding Material • Magnesium Alloy A5052 • A7075 • AZ91 • AZ80A		Aluminum Alloy Casting AC4C • ADC		Copper Alloy C1100					
Vc (m/min)	80		80		60					
DC X LU	S (min ⁻¹)	F (mm/min)	S (min ⁻¹)	F (mm/min)	S (min ⁻¹)	F (mm/min)				
1 x 3	16.000	350	16.000	350	10.000	100				
1,5 x 4,5	16.000	350	16.000	350	9.000	100				
2 x 6	12.750	350	12.750	350	8.500	100				
2,5 x 7,5	10.000	350	10.000	350	6.400	100				
3 x 9	8.500	400	8.500	400	6.400	120				
4 x 12	6.400	400	6.400	400	4.800	120				
5 x 15	5.100	400	5.100	400	3.800	120				
6 x 18	4.200	450	4.200	450	3.100	130				
8 x 24	3.200	500	3.200	500	2.400	150				
10 x 30	2.550	500	2.550	500	1.900	150				
12 x 36	2.100	500	2.100	500	1.600	150				
16 x 48	1.600	550	1.600	550	1.200	170				
20 x 60	1.300	550	1.300	550	960	170				
25 x 75	1.020	550	1.020	550	770	170				
Depth of cut	<table border="1"> <tr><td>ap</td></tr> <tr><td>1D</td></tr> </table>				ap	1D	<table border="1"> <tr><td>ap</td></tr> <tr><td>0,5D</td></tr> </table>		ap	0,5D
ap										
1D										
ap										
0,5D										
<p>1. The above milling condition is a guideline for the overhang length is 4xD. 2. Use a rigid and precise machine and holder. 3. The indicated speeds and feeds are for milling with water-soluble coolant. 4. Please adjust the speed and feed when the cutting depth is large or when machines with low rigidity are used. 5. Reduce speed and feed as well as depth of cut when high precision is required. 6. Adjust the speed and feed accordingly when the overhang length is longer than specified (refer to p.10). 7. When the chips wind around the end mill, reduce the speed and feed. 8. Please always use the appropriate cutting fluid recommended by the cutting fluid manufacturer in the machining of magnesium alloys. Be cautious with the cutting chips as they are highly flammable and may pose a serious fire risk if not properly handled.</p>										

Cutting Condition Guide for Changes in Overhang Length

DC = Ø6, Ø8

	Work Material	Aluminum Alloy Expanding Material • Magnesium Alloy A5052 • A7075 • AZ91 • AZ80A		Aluminum Alloy Casting AC4C • ADC		Copper Alloy C1100	
		S (min ⁻¹)	F (mm/min)	S (min ⁻¹)	F (mm/min)	S (min ⁻¹)	F (mm/min)
Slot milling	5		70%		70%		70%
	6		40%		40%		40%
Side milling	5		70%		70%		70%
	6		50%		50%		50%
Plunging	5		80%		80%		80%
	6		60%		60%		60%

Milling | Solid carbide



CUTTING CONDITIONS

Milling | Endmills | Cutting conditions

AE-TL-N Applies to square/sharp corner edge/radius type

3XD Cutting length

Slot Milling

Vc (m/min)	Aluminum Alloy Expanding Material • Magnesium Alloy A5052 • A7075 • AZ91 • AZ80A		Aluminum Alloy Casting AC4C • ADC		Copper Alloy C1100	
	S (min ⁻¹)	F (mm/min)	S (min ⁻¹)	F (mm/min)	S (min ⁻¹)	F (mm/min)
240			240		120	
DC x APMX						
3 x 9	25.600	1.380	25.600	1.380	12.800	770
4 x 12	19.200	1.420	19.200	1.420	9.600	820
5 x 15	15.360	1.470	15.360	1.470	7.680	870
6 x 18	12.800	1.520	12.800	1.520	6.400	930
8 x 24	9.600	1.620	9.600	1.620	4.800	1.040
10 x 30	7.680	1.720	7.680	1.720	3.840	1.140
12 x 36	6.400	1.820	6.400	1.820	3.200	1.250
16 x 48	4.800	1.920	4.800	1.920	2.400	1.320
20 x 60	3.800	2.020	3.800	2.020	1.900	1.390
25 x 75	3.060	2.120	3.060	2.120	1.530	1.460
Depth of cut	ap 1D				ap 0,5D	

1. Use a rigid and precise machine and holder.
2. The indicated speeds and feeds are for milling with water-soluble coolant.
3. Please adjust the speed and feed when the cutting depth is large or when machines with low rigidity are used.
4. Reduce speed and feed as well as depth of cut when high precision is required.
5. Please always use the appropriate cutting fluid recommended by the cutting fluid manufacturer in the machining of magnesium alloys. Be cautious with the cutting chips as they are highly flammable and may pose a serious fire risk if not properly handled.

Side Milling

Vc (m/min)	Aluminum Alloy Expanding Material • Magnesium Alloy A5052 • A7075 • AZ91 • AZ80A		Aluminum Alloy Casting AC4C • ADC		Copper Alloy C1100	
	S (min ⁻¹)	F (mm/min)	S (min ⁻¹)	F (mm/min)	S (min ⁻¹)	F (mm/min)
240			240		120	
DC x APMX						
3 x 9	25.600	1.720	25.600	1.720	12.800	960
4 x 12	19.200	1.780	19.200	1.780	9.600	1.020
5 x 15	15.360	1.840	15.360	1.840	7.680	1.080
6 x 18	12.800	1.900	12.800	1.900	6.400	1.160
8 x 24	9.600	2.030	9.600	2.030	4.800	1.300
10 x 30	7.680	2.150	7.680	2.150	3.840	1.420
12 x 36	6.400	2.270	6.400	2.270	3.200	1.550
16 x 48	4.800	2.390	4.800	2.390	2.400	1.630
20 x 60	3.800	2.510	3.800	2.510	1.900	1.710
25 x 75	3.060	2.640	3.060	2.640	1.530	1.800
Depth of cut	ap 3D		ae 0,1D			

1. Use a rigid and precise machine and holder.
2. The indicated speeds and feeds are for milling with water-soluble coolant.
3. Please adjust the speed and feed when the cutting depth is large or when machines with low rigidity are used.
4. Reduce speed and feed as well as depth of cut when high precision is required.
5. Please always use the appropriate cutting fluid recommended by the cutting fluid manufacturer in the machining of magnesium alloys. Be cautious with the cutting chips as they are highly flammable and may pose a serious fire risk if not properly handled.

CUTTING CONDITIONS

Milling | Endmills | Cutting conditions

AE-TL-N Applies to square/sharp corner edge/radius type

3XD Cutting length

Plunging

	Aluminum Alloy Expanding Material • Magnesium Alloy A5052 • A7075 • AZ91 • AZ80A		Aluminum Alloy Casting AC4C • ADC		Copper Alloy C1100					
Vc (m/min)	70		70		50					
DC x APMX	S (min ⁻¹)	F (mm/min)	S (min ⁻¹)	F (mm/min)	S (min ⁻¹)	F (mm/min)				
3 x 9	7.500	350	7.500	350	5.300	100				
4 x 12	5.600	350	5.600	350	3.980	100				
5 x 15	4.460	350	4.460	350	3.180	100				
6 x 18	3.680	400	3.680	400	2.650	110				
8 x 24	2.800	450	2.800	450	1.990	120				
10 x 30	2.230	450	2.230	450	1.590	120				
12 x 36	1.840	450	1.840	450	1.330	120				
16 x 48	1.400	500	1.400	500	1.000	130				
20 x 60	1.100	500	1.100	500	800	130				
25 x 75	890	500	890	500	640	130				
Depth of cut	<table border="1"> <tr> <td>ap</td> </tr> <tr> <td>1D</td> </tr> </table>				ap	1D	<table border="1"> <tr> <td>ap</td> </tr> <tr> <td>0,5D</td> </tr> </table>		ap	0,5D
ap										
1D										
ap										
0,5D										

1. Use a rigid and precise machine and holder.
2. The indicated speeds and feeds are for milling with water-soluble coolant.
3. Please adjust the speed and feed when the cutting depth is large or when machines with low rigidity are used.
4. Reduce speed and feed as well as depth of cut when high precision is required.
5. When the chips wind around the end mill, reduce the speed and feed.
6. Please always use the appropriate cutting fluid recommended by the cutting fluid manufacturer in the machining of magnesium alloys. Be cautious with the cutting chips as they are highly flammable and may pose a serious fire risk if not properly handled.

AE-TL-N

5XD Cutting length

Side Milling

	Aluminum Alloy Expanding Material • Magnesium Alloy A5052 • A7075 • AZ91 • AZ80A		Aluminum Alloy Casting AC4C • ADC		Copper Alloy C1100					
Vc (m/min)	100		100		50					
DC x APMX	S (min ⁻¹)	F (mm/min)	S (min ⁻¹)	F (mm/min)	S (min ⁻¹)	F (mm/min)				
3 x 15	10.600	640	10.600	640	5.300	200				
4 x 20	8.000	690	8.000	690	4.000	210				
5 x 25	6.400	730	6.400	730	3.200	230				
6 x 30	5.300	780	5.300	780	2.600	240				
8 x 40	4.000	870	4.000	870	2.000	260				
10 x 50	3.200	960	3.200	960	1.600	290				
12 x 60	2.700	1.050	2.700	1.050	1.300	320				
16 x 60	2.000	1.140	2.000	1.140	1.000	350				
20 x 80	1.600	1.230	1.600	1.230	800	380				
25 x 125	1.300	1.320	1.300	1.320	640	400				
Depth of cut	<table border="1"> <tr> <td>ap</td> <td>ae</td> </tr> <tr> <td>5D</td> <td>0,1D</td> </tr> </table>				ap	ae	5D	0,1D		
ap	ae									
5D	0,1D									

1. Use a rigid and precise machine and holder.
2. The indicated speeds and feeds are for milling with water-soluble coolant.
3. Please adjust the speed and feed when the cutting depth is large or when machines with low rigidity are used.
4. Reduce speed and feed as well as depth of cut when high precision is required.
5. Please always use the appropriate cutting fluid recommended by the cutting fluid manufacturer in the machining of magnesium alloys. Be cautious with the cutting chips as they are highly flammable and may pose a serious fire risk if not properly handled.

Milling | Solid carbide



KEY FEATURES: AE-VTS-N



1 Variable lead and unequal spacing teeth

2 Stable and high efficiency milling is made possible by the suppression of chattering

3 DLC-IGUSS Coating

Due to the smoothness of the coating surface, it is extremely effective for non-ferrous materials such as aluminum alloys that require welding resistance and lubricity. Moreover, tool durability is also improved.



SUITABLE FOR A WIDE RANGE OF APPLICATIONS! HIGH EFFICIENCY AND HIGH QUALITY PROCESSING

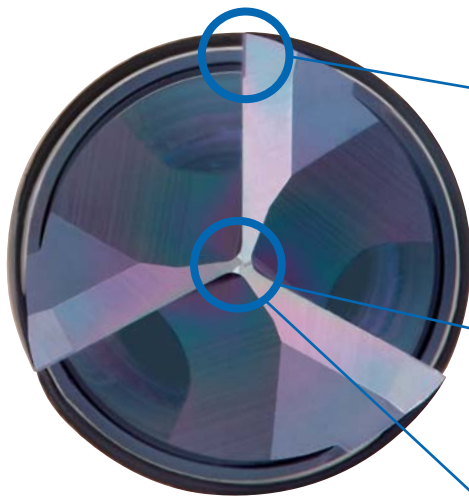

Flat cutting edge

Achieves higher precision machined surface quality

Center cutting edge

Can be used for plunging

3 cutting edges that connect at the center

The cutting load is equalized among the cutting edges with greater stability to enable high speed milling*

*Effective for plunging and ramping

Variable lead and unequal spacing teeth

Stable and high efficiency milling is made possible by the suppression of chattering

Suppression of Vibration

Variable lead and unequal spacing teeth geometry enable stable and high efficiency milling

Variable Leads	Unequal Spacing Teeth
<p>β_1 β_2 $\beta_1 \neq \beta_2$</p>	<p>α_1 α_2 α_3 $\alpha_1 \neq \alpha_2 \neq \alpha_3$</p>



SUITABLE FOR A WIDE RANGE OF APPLICATIONS! HIGH EFFICIENCY AND HIGH QUALITY PROCESSING

Excellent surface finish

Due to the effect of the DLC coating and the flat cutting edge specification, excellent machined surface quality is achieved.

Tool	AE-VTS-N φ10×30	Non-coated Competitor φ10 3 Flutes
Work Material	A7075	
Milling Method	Slot Milling	
Cutting Speed	300m/min (9.550min ⁻¹)	
Feed	1.432mm/min(0.05mm/t)	
Depth of Cut	ap =10mm	
Coolant	Water Soluble	
Machine	Vertical Machining Center (BT40)	

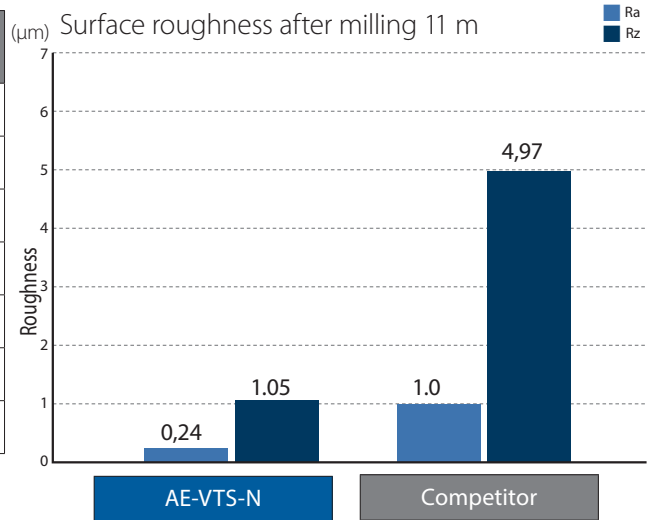

Good machined surface quality even under high speed cutting condition

Due to the anti-welding effect of the DLC coating, the anti-vibration effect of the variable lead and unequal spacing teeth geometry, and the effect of the flat cutting edge specification, good machined surface can be achieved even under aggressive cutting condition.

Tool	AE-VTS-N φ10×30	Non-coated Competitor φ10 3 Flutes
Work Material	A7075	
Milling Method	Slot Milling	
Cutting Speed	408m/min (13.000min ⁻¹)	300m/min (9.550min ⁻¹)
Feed	4.780mm/min (0,123mm/t)	1.432mm/min (0,05mm/t)
Depth of Cut	ap =10mm	
Coolant	Water Soluble	
Machine	Vertical Machining Center (BT40)	

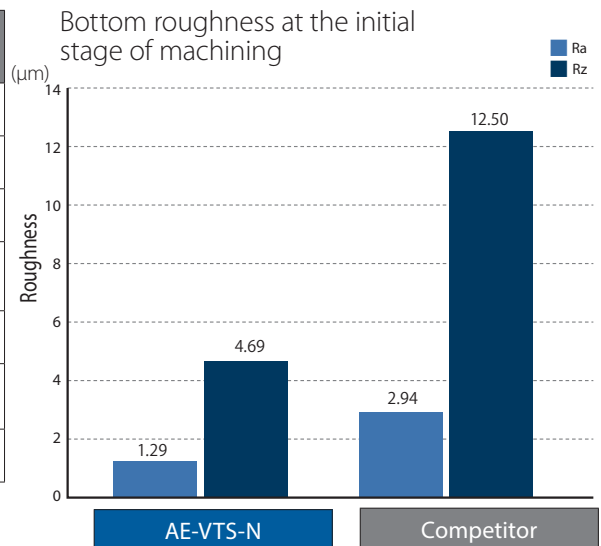

Milling | Solid carbide

AE-VTS-N

Milling | Solid carbide

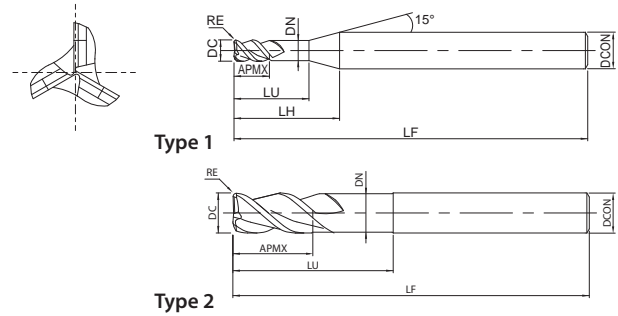

- First choice in quality and performance
- Carbide end mill with DLC-IGUSS coating
- For non-ferrous materials
- 3 flutes, variable helix and unequal spacing



EDP	ZEFP	DC	RE	LU	LF	APMX	LH	DCON	DN	Type
8557243	3	1	-	3	45	1,5	8,6	4	0,95	1
8557244	3	1,5	-	4,5	45	2,3	9,3	4	1,45	1
8557245	3	2	-	6	45	3	10,1	4	1,95	1
8557246	3	2,5	-	7,5	45	3,8	10,6	4	2,4	1
8557360	3	3	-	9	55	4,5	14,9	6	2,85	1
8557400	3	3	0,2	9	55	4,5	14,8	6	2,85	1
8557401	3	3	0,5	9	55	4,5	14,8	6	2,85	1
8557361	3	4	-	12	55	6	16	6	3,8	1
8557402	3	4	0,2	12	55	6	15,9	6	3,8	1
8557403	3	4	0,5	12	55	6	15,9	6	3,8	1
8557404	3	4	1	12	55	6	15,9	6	3,8	1
8557362	3	5	-	15	55	7,5	17,1	6	4,8	1
8557405	3	5	0,2	15	55	7,5	16,8	6	4,8	1
8557406	3	5	0,5	15	55	7,5	16,8	6	4,8	1
8557407	3	5	1	15	55	7,5	16,8	6	4,8	1
8557363	3	6	-	18	60	9	-	6	5,8	2
8557408	3	6	0,3	18	60	9	-	6	5,8	2
8557409	3	6	0,5	18	60	9	-	6	5,8	2
8557410	3	6	1	18	60	9	-	6	5,8	2
8557364	3	8	-	24	70	12	-	8	7,7	2
8557411	3	8	0,3	24	70	12	-	8	7,7	2
8557412	3	8	0,5	24	70	12	-	8	7,7	2
8557413	3	8	1	24	70	12	-	8	7,7	2
8557414	3	8	1,5	24	70	12	-	8	7,7	2
8557415	3	8	2	24	70	12	-	8	7,7	2
8557365	3	10	-	30	75	15	-	10	9,7	2
8557416	3	10	0,3	30	75	15	-	10	9,7	2
8557417	3	10	0,5	30	75	15	-	10	9,7	2
8557418	3	10	1	30	75	15	-	10	9,7	2
8557419	3	10	1,5	30	75	15	-	10	9,7	2
8557420	3	10	2	30	75	15	-	10	9,7	2
8557421	3	10	3	30	75	15	-	10	9,7	2
8557366	3	12	-	36	80	18	-	12	11,7	2
8557422	3	12	0,3	36	80	18	-	12	11,7	2
8557423	3	12	0,5	36	80	18	-	12	11,7	2
8557424	3	12	1	36	80	18	-	12	11,7	2
8557425	3	12	1,5	36	80	18	-	12	11,7	2
8557426	3	12	2	36	80	18	-	12	11,7	2
8557427	3	12	3	36	80	18	-	12	11,7	2

Milling | Solid carbide



CUTTING CONDITIONS

Milling | Endmills | Cutting conditions

AE-VTS-N Applies to square/sharp corner edge/radius type

Slot Milling

Vc (m/min)	Aluminum Alloy Expanding Material • Magnesium Alloy A5052 • A7075 • AZ91 • AZ80A		Aluminum Alloy Casting AC4C • ADC		Copper Alloy C1100					
	300~400		300~400		150~200					
DC X LU	S (min ⁻¹)	F (mm/min)	S (min ⁻¹)	F (mm/min)	S (min ⁻¹)	F (mm/min)				
1 x 3	32.000	1.430	32.000	1.430	16.000	660				
1,5 x 4,5	32.000	1.630	32.000	1.630	16.000	720				
2 x 6	32.000	1.920	32.000	1.920	16.000	800				
2,5 x 7,5	32.000	2.880	32.000	2.880	16.000	1.080				
3 x 9	32.000	3.820	32.000	3.820	16.000	1.430				
4 x 12	24.000	3.960	24.000	3.960	12.000	1.530				
5 x 15	19.200	4.090	19.200	4.090	9.600	1.640				
6 x 18	18.500	4.230	18.500	4.230	9.300	1.740				
8 x 24	16.000	4.510	16.000	4.510	8.000	1.940				
10 x 30	13.000	4.780	13.000	4.780	6.400	2.150				
12 x 36	11.000	5.050	11.000	5.050	5.300	2.360				
Depth of cut	<table border="1"> <tr><td>ap</td></tr> <tr><td>1D</td></tr> </table>				ap	1D	<table border="1"> <tr><td>ap</td></tr> <tr><td>0,5D</td></tr> </table>		ap	0,5D
ap										
1D										
ap										
0,5D										

Side Milling

Vc (m/min)	Aluminum Alloy Expanding Material • Magnesium Alloy A5052 • A7075 • AZ91 • AZ80A		Aluminum Alloy Casting AC4C • ADC		Copper Alloy C1100									
	300~400		300~400		150~200									
DC X LU	S (min ⁻¹)	F (mm/min)	S (min ⁻¹)	F (mm/min)	S (min ⁻¹)	F (mm/min)								
1 x 3	32.000	1.430	32.000	1.430	16.000	720								
1,5 x 4,5	32.000	1.630	32.000	1.630	16.000	800								
2 x 6	32.000	1.920	32.000	1.920	16.000	1.080								
2,5 x 7,5	32.000	2.880	32.000	2.880	16.000	1.200								
3 x 9	32.000	3.820	32.000	3.820	16.000	1.600								
4 x 12	24.000	3.960	24.000	3.960	12.000	1.700								
5 x 15	19.200	4.090	19.200	4.090	9.600	1.830								
6 x 18	18.500	4.230	18.500	4.230	9.300	1.950								
8 x 24	16.000	4.510	16.000	4.510	8.000	2.180								
10 x 30	13.000	4.780	13.000	4.780	6.400	2.400								
12 x 36	11.000	5.050	11.000	5.050	5.300	2.650								
Depth of cut	<table border="1"> <tr><td>ap</td><td>ae</td></tr> <tr><td>1,5D</td><td>0,2D</td></tr> </table>				ap	ae	1,5D	0,2D	<table border="1"> <tr><td>ap</td><td>ae</td></tr> <tr><td>1,5D</td><td>0,1D</td></tr> </table>		ap	ae	1,5D	0,1D
ap	ae													
1,5D	0,2D													
ap	ae													
1,5D	0,1D													

1. The above milling condition is a guideline for the overhang length is 4xD.
2. Use a rigid and precise machine and holder.
3. The indicated speeds and feeds are for milling with water-soluble coolant.
4. Please adjust the speed and feed when the cutting depth is large or when machines with low rigidity are used.
5. Reduce speed and feed as well as depth of cut when high precision is required.
6. Adjust the speed and feed accordingly when the overhang length is longer than specified (refer to p.18).
7. Please always use the appropriate cutting fluid recommended by the cutting fluid manufacturer in the machining of magnesium alloys. Be cautious with the cutting chips as they are highly flammable and may pose a serious fire risk if not properly handled.



CUTTING CONDITIONS

Milling | Endmills | Cutting conditions

AE-VTS-N Applies to square/sharp corner edge/radius type

Plunging

	Aluminum Alloy Expanding Material • Magnesium Alloy A5052 • A7075 • AZ91 • AZ80A		Aluminum Alloy Casting AC4C • ADC		Copper Alloy C1100	
Vc (m/min)	150		150		75	
DC X LU	S (min ⁻¹)	F (mm/min)	S (min ⁻¹)	F (mm/min)	S (min ⁻¹)	F (mm/min)
1 x 3	20.000	400	20.000	400	10.000	120
1,5 x 4,5	20.000	400	20.000	400	10.000	120
2 x 6	20.000	400	20.000	400	10.000	120
2,5 x 7,5	20.000	400	20.000	400	10.000	120
3 x 9	15.900	500	15.900	500	8.000	150
4 x 12	12.000	500	12.000	500	6.000	150
5 x 15	9.600	500	9.600	500	4.800	150
6 x 18	8.000	600	8.000	600	4.000	180
8 x 24	6.000	700	6.000	700	3.000	210
10 x 30	4.800	700	4.800	700	2.400	210
12 x 36	4.000	700	4.000	700	2.000	210
Depth of cut	$\frac{ap}{1D}$				$\frac{ap}{0,5D}$	
<p>1. The above milling condition is a guideline for the overhang length is 4xD. 2. Use a rigid and precise machine and holder. 3. The indicated speeds and feeds are for milling with water-soluble coolant. 4. Please adjust the speed and feed when the cutting depth is large or when machines with low rigidity are used. 5. Reduce speed and feed as well as depth of cut when high precision is required. 6. Adjust the speed and feed accordingly when the overhang length is longer than specified. 7. When the chips wind around the end mill, reduce the speed and feed. 8. Please always use the appropriate cutting fluid recommended by the cutting fluid manufacturer in the machining of magnesium alloys. Be cautious with the cutting chips as they are highly flammable and may pose a serious fire risk if not properly handled.</p>						

Cutting Condition Guide for Changes in Overhang Length

DC = Ø6, Ø8

	Work Material	Aluminum Alloy Expanding Material • Magnesium Alloy A5052 • A7075 • AZ91 • AZ80A		Aluminum Alloy Casting AC4C • ADC		Copper Alloy C1100	
		L/D	S (min ⁻¹)	F (mm/min)	S (min ⁻¹)	F (mm/min)	S (min ⁻¹)
Slot milling	5		70%		70%		70%
	6	70%	20%	70%	20%	70%	20%
Side milling	5		70%		70%		70%
	6		50%		50%		50%
Plunging	5		80%		80%		80%
	6		60%		60%		60%

Milling | Solid carbide



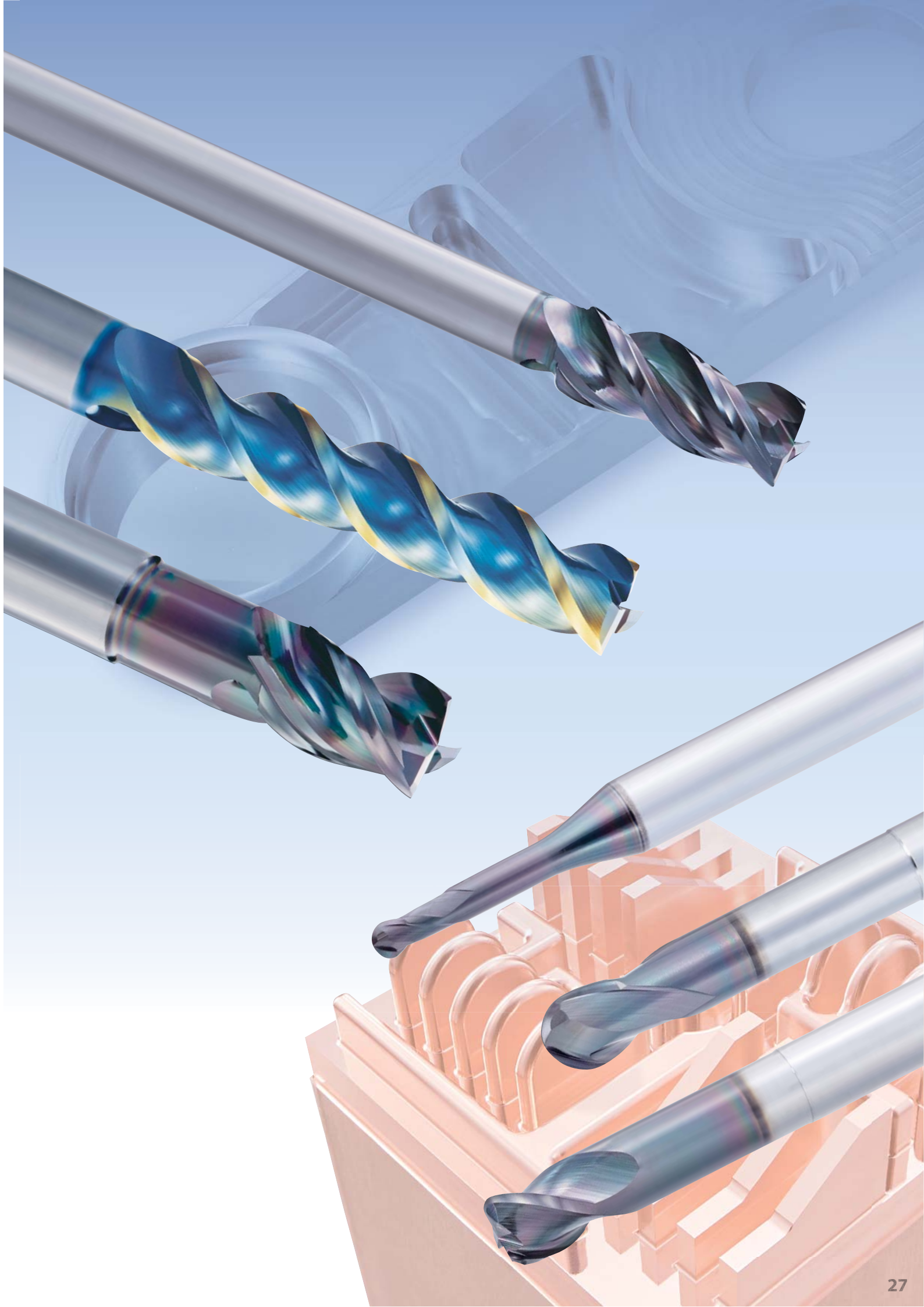

KEY FEATURES: AE-VTFE-N

Highly efficient and highly accurate deep side milling at L/D of 5 or more



2.5×D cutting length

- Highly efficient deep side milling is possible with large step milling of up to 2×D*

The recommended depth of cut varies depending on the overhang length. See p.33 for details.

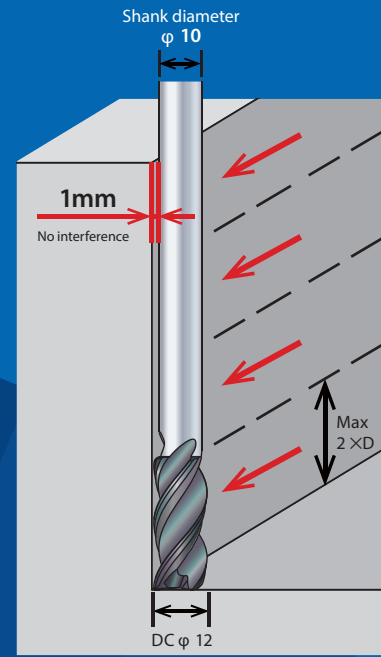

DC > Shank diameter

Long length reduced shank type

- Reduced shank types are tools with an outer diameter that is larger than the shank diameter
- Suitable for deep side milling and pocket milling of non-ferrous metal parts
- Supports various machining depths by changing the overhang length

Flat cutting edge specification

Achieves high quality bottom surface milling with long overhang length

3 cutting edges that connect at the center

The cutting load is equalized among the cutting edges with greater stability

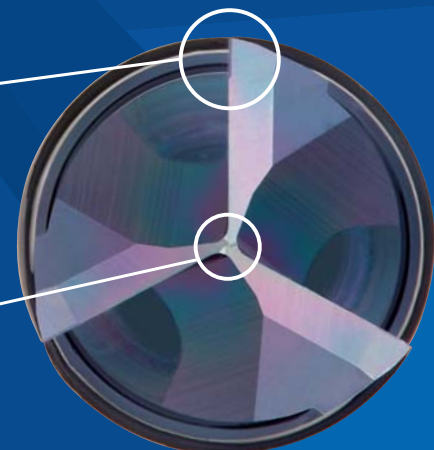

DLC COATED CARBIDE END MILL FOR NON-FERROUS MATERIALS HIGH PERFORMANCE TYPE FOR DEEP SIDE MILLING

High Milling Quality Suppresses streak generation

The R shape on the shank side edge suppresses the generation of streaks due to step milling

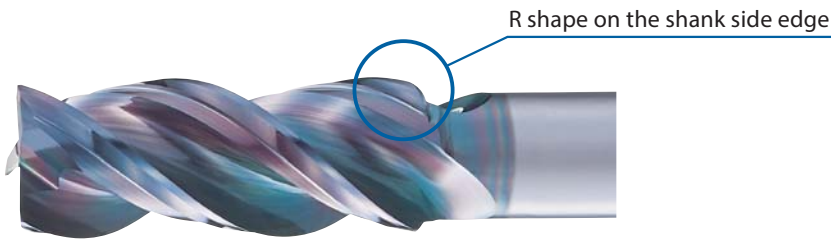

Stable Performance Suppression of vibration

Variable lead and unequal spacing teeth geometry enable stable and high efficiency milling

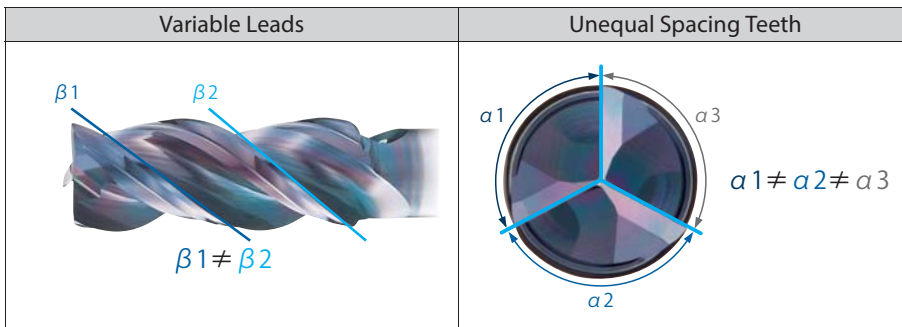

Durability DLC-IGUSS Coating

Due to the smoothness of the coating surface, it is extremely effective for non-ferrous materials such as aluminum alloys that require welding resistance and lubricity. Moreover, tool durability is also improved.



CUTTING DATA

High precision deep side milling

Achieves good accuracy deep side milling at L/D = 8

Tool	AE-VTFE-N Ø12	Competitor Ø12
Work Material	A7075	
Milling Method	Side Step Milling	
Cutting Speed	100 m/min (2.650 min ⁻¹)	
Feed	955mm/min (0,12 mm/t)	
Depth of Cut	ap = 12mm X 7 Times ae = 0,6mm	
Overhang Length	96mm L/D=8	
Coolant	Water Soluble	
Machine	Vertical Machining Center (BT40)	

Comparison of the amount of deflection of the machined surface

The initial stage of machining

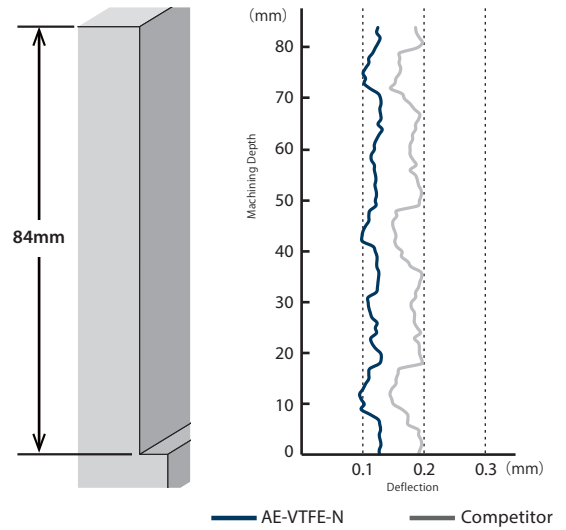

Achieves better machining accuracy compared to conventional long type

Tool	AE-VTFE-N Ø12	Conventional long type Ø12
Work Material	A7075	
Milling Method	Side Step Milling	Side milling
Cutting Speed	200m/min (5.305 min ⁻¹)	100m/min (2.700 min ⁻¹)
Feed	1.910mm/min (0,12 mm/t)	1.050mm/min (0,13 mm/t)
Depth of Cut	ap = 24mm X 2 Times + 12mm ae = 1,2mm	ap = 60mm ae = 1mm
Overhang Length	72mm L/D=6	
Coolant	Water Soluble	
Machine	Vertical Machining Center (BT40)	

Comparison of the amount of deflection of the machined surface

The initial stage of machining

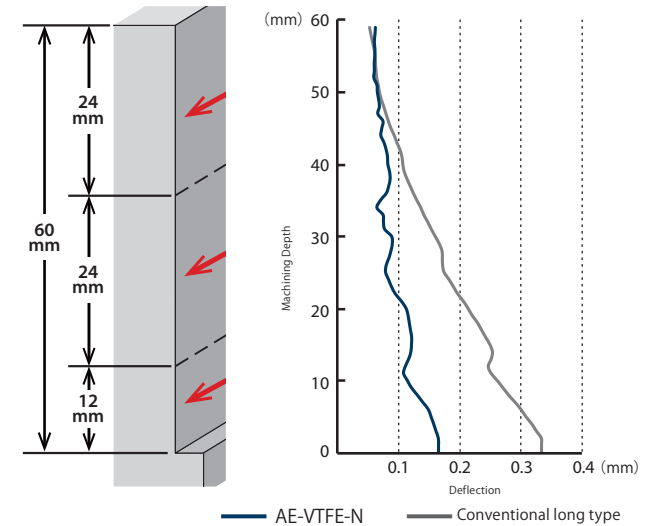

CUTTING DATA

Stable slot milling at L/D=5

Due to the effect of the flat cutting edge specification, excellent machined surface quality is achieved.

Tool	AE-VTFE-N Ø12	Conventional Ø12	Competitor Ø12
Work Material	A5052		
Milling Method	Slot Milling		
Cutting Speed	200m/min (5.305 min ⁻¹)		
Feed	1.910mm/min (0,12 mm/t)		
Depth of Cut	ap = 2,4mm (0,2D)		
Overhang Length	60mm L/D=5		
Coolant	Water Soluble		
Machine	Vertical Machining Center (BT40)		

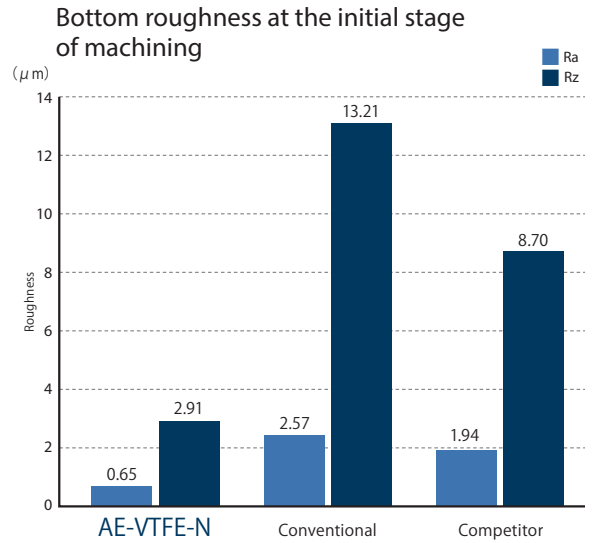

Good machined surface



CUTTING CONDITIONS

Milling | Endmills | Cutting conditions

AE-VTFE-N Applies to square/radius type

Slot Milling

Vc (m/min)	Aluminum Alloy Expanding Material • Magnesium Alloy A5052 • A7075 • AZ91 • AZ80A		Aluminum Alloy Casting AC4C • ADC		Copper Alloy C1100	
	S (min ⁻¹)	F (mm/min)	S (min ⁻¹)	F (mm/min)	S (min ⁻¹)	F (mm/min)
6	8.490	1.530	8.490	1.530	4.250	640
8	6.370	1.150	6.370	1.150	3.180	480
10	6.370	1.910	6.370	1.910	3.180	760
12	5.310	1.910	5.310	1.910	2.650	640
14	4.550	1.640	4.550	1.640	2.270	540
18	3.540	1.270	3.540	1.270	1.770	420
22	2.900	1.040	2.900	1.040	1.450	350

Depth of cut		ap
	DC ≤ Ø10	0,1D
	10 < DC	0,2D

- The above milling condition is a guideline for the overhang length is 5xD.
- Use a rigid and precise machine and holder.
- The indicated speeds and feeds are for milling with water-soluble coolant.
- Please adjust the speed and feed when the cutting depth is large or when machines with low rigidity are used.
- Reduce speed and feed as well as depth of cut when high precision is required.
- Adjust the speed and feed accordingly when the overhang length is longer than specified (refer to p.34).
- When the chips wind around the end mill, reduce the speed and feed.
- Please always use the appropriate cutting fluid recommended by the cutting fluid manufacturer in the machining of magnesium alloys. Be cautious with the cutting chips as they are highly flammable and may pose a serious fire risk if not properly handled.

AE-VTFE-N Applies to square/radius type

Side Milling

Vc (m/min)	Aluminum Alloy Expanding Material • Magnesium Alloy A5052 • A7075 • AZ91 • AZ80A		Aluminum Alloy Casting AC4C • ADC		Copper Alloy C1100	
	S (min ⁻¹)	F (mm/min)	S (min ⁻¹)	F (mm/min)	S (min ⁻¹)	F (mm/min)
6	15.920	2.870	15.920	2.870	7.960	1.190
8	11.940	2.150	11.940	2.150	5.970	1.070
10	9.550	2.870	9.550	2.870	4.780	1.000
12	7.960	2.870	7.960	2.870	3.980	960
14	6.820	2.460	6.820	2.460	3.410	820
18	5.310	1.910	5.310	1.910	2.650	640
22	4.340	1.560	4.340	1.560	2.170	520

Depth of cut	ap	ae
	2D	0,1D

- The above milling condition is a guideline for the overhang length is 5xD.
- Use a rigid and precise machine and holder.
- The indicated speeds and feeds are for milling with water-soluble coolant.
- Please adjust the speed and feed when the cutting depth is large or when machines with low rigidity are used.
- Reduce speed and feed as well as depth of cut when high precision is required.
- Adjust the speed and feed accordingly when the overhang length is longer than specified (refer to p.34).
- When the chips wind around the end mill, reduce the speed and feed.
- Please always use the appropriate cutting fluid recommended by the cutting fluid manufacturer in the machining of magnesium alloys. Be cautious with the cutting chips as they are highly flammable and may pose a serious fire risk if not properly handled.

Milling | Solid carbide



Cutting Condition Guide for Changes in Overhang Length

Work Material	L/D	Aluminum Alloy Expanding Material • Magnesium Alloy A5052 • A7075 • AZ91 • AZ80A			Aluminum Alloy Casting AC4C • ADC			Copper Alloy C1100					
		S (min ⁻¹)	F (mm/min)	Depth of Cut		S (min ⁻¹)	F (mm/min)	Depth of Cut		S (min ⁻¹)	F (mm/min)	Depth of Cut	
				ap	ae			ap	ae			ap	ae
Slot milling	6	50%	50%	0,015D	-	50%	50%	0,015D	-	50%	50%	0,015D	-
	7	30%	20%	0,01D	-	30%	20%	0,01D	-	30%	20%	0,01D	-
Side milling	6	65%	60%	2D	0,05D	65%	60%	2D	0,05D	90%	90%	2D	0,05D
	7	55%	50%	2D	0,03D	55%	50%	2D	0,03D	70%	70%	2D	0,03D
	8	45%	45%	2D	0,025D	45%	45%	2D	0,025D	65%	65%	2D	0,01D

KEY FEATURES: AE-LNBD-N

Milling beautiful copper electrodes without burrs!

Excellent machined surface accuracy

Beautiful edge without burrs



Ball specifications that enable high quality milling

1 Optimal cutting edge shape for milling copper alloy

2 Superior ball R precision

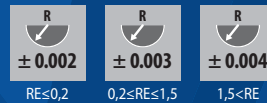

3 High quality primary relief surface

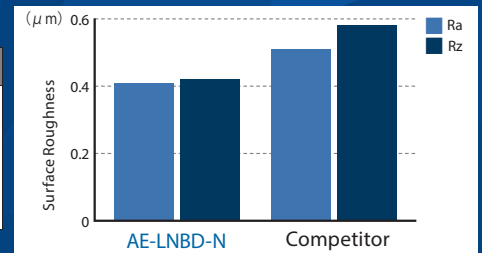
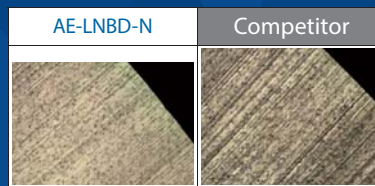

Teardrop-shaped outer periphery

Strong back taper geometry enables milling by point, which prevents chattering and chipping, resulting in improvement of surface accuracy.

Note: Teardrop-shaped specification does not apply to items above R2.



Superior shank accuracy

Supports h4 tolerance (0/0,004)



UNIQUE DLC COATING THAT REVAMPS COPPER ELECTRODE MACHINING

Due to its smooth surface and extremely low coefficient of friction, DLC coating is extremely effective against non-ferrous metals such as copper alloys, which require welding resistance and lubricity.

DLC-IGUSS coating

Name of Coating	Coating Color	Coating Type	(GPa) Hardness	Oxidation Temperature (C°)	Coefficient of Friction	(µm) Coating Thickness	Coating Temperature (C°)	Surface roughness	Wear Resistance	Welding Resistance	Toughness
DLC-IGUSS	Interference Color	DLC(SP ³ Rich)	60	550	0.10	0.8	400	☆	☉	☆	○

(Good) ○ → ☉ → ☆ (Best)

Wear resistance

DLC-IGUSS is effective in suppressing wear against tough-pitch copper (C1100), and stable machining accuracy can be obtained for a long period of time.

Tool	2 Flutes Carbide Ball End Mill
Work Material	C1100
Milling Method	Pick Milling
Cutting Speed	141 m/min (15.000 min ⁻¹)
Feed	1.500mm/min (0,05 mm/t)
Depth of Cut	ap = 1,5mm Pf = 0,05mm
Coolant	Water Soluble
Machine	Vertical Machining Center (BT40)

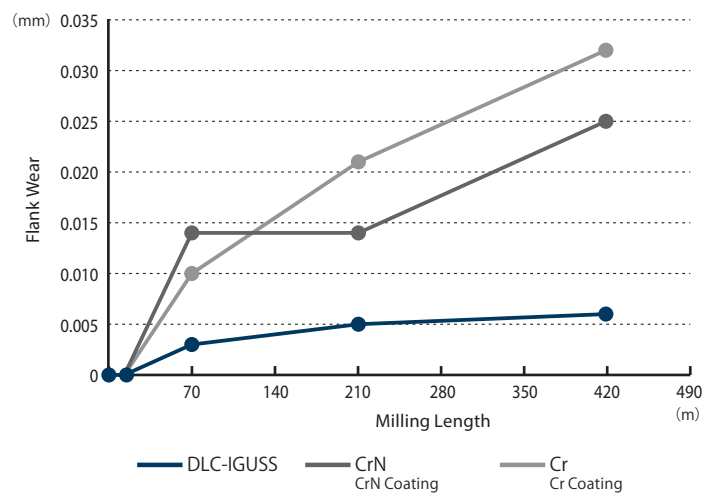

Wear condition of ball flank after milling 420m



CUTTING DATA

Long Tool Life

DLC-IGUSS coating enables consistent tool wear

Tool	AE-LNBD-N R1X10X4
Work Material	C1100
Milling Method	Pick Milling
Cutting Speed	126m/min (20.000 min ⁻¹)
Feed	2.000mm/min (0,05 mm/t)
Depth of Cut	ap = 0,2mm (0,1D) Pf = 0,4mm (0,2D)
Coolant	Water Soluble
Machine	Horizontal Machining Center (BT40)

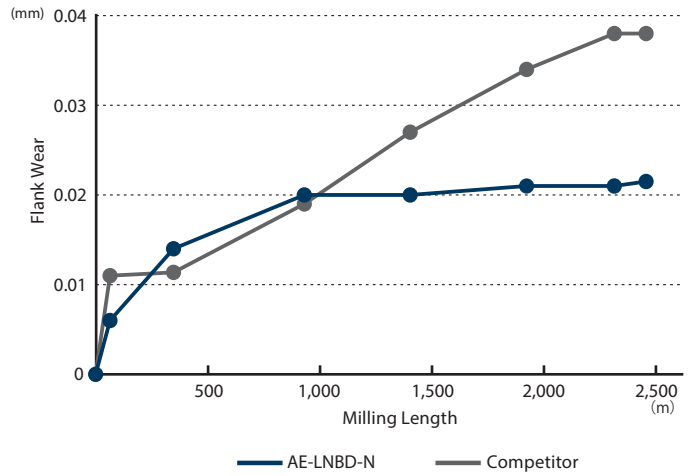

Wear condition of ball flank after milling 2.480m

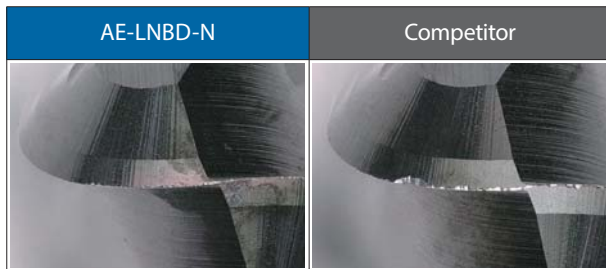

Exhibits superior endurance in copper tungsten

Tool	AE-LNBD-N R1X10X4
Work Material	Copper Tungsten
Milling Method	Pick Milling
Cutting Speed	101m/min (16.000 min ⁻¹)
Feed	1.400mm/min (0,04 mm/t)
Depth of Cut	ap = 0,2mm (0,1D) Pf = 0,4mm (0,2D)
Coolant	Water Soluble
Machine	Horizontal Machining Center (BT40)

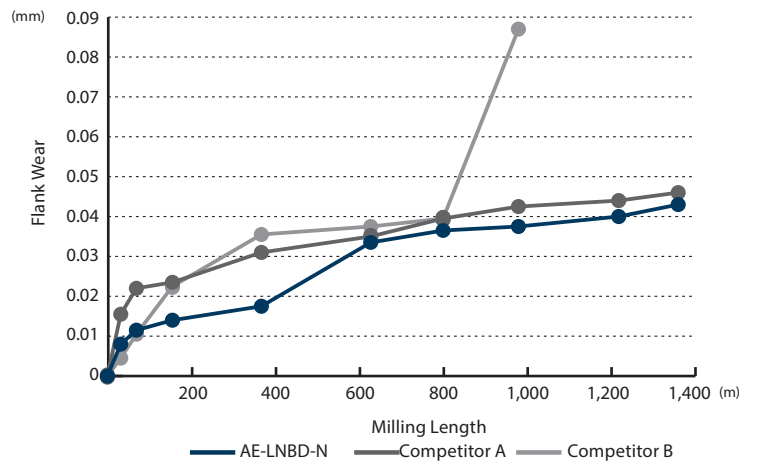

Wear condition of ball flank



Milling | Solid carbide



CUTTING DATA

Achieves good machined surface without burrs compared to conventional products

(C1100)

Work Material : Tough-Pitch Copper

Work Size: 60x60 (Milling Depth 10mm)

(HSK-E32)

Machine : Vertical Machining Center

Coolant: MQL*

Watch it in action



* MQL is used for filming the video.

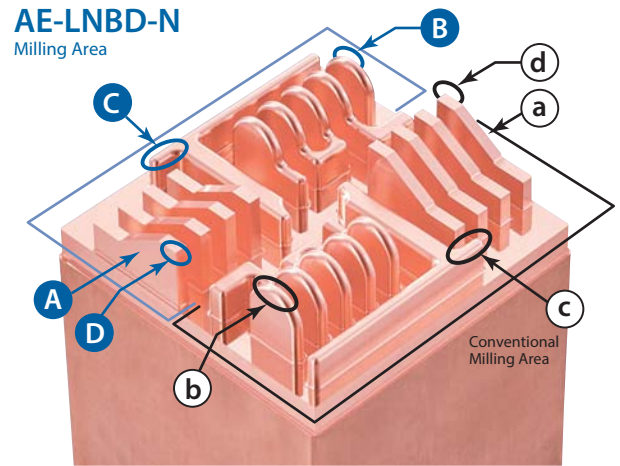

Tool	Process	Condition of Machined Surface			Condition of Burrs
AE-LNBD-N R1x10x4	⑤	A Ra : 0.1125μm	B Tear	C Collapse of Shape	D
Conventional (Cr Coating) R1x10x4	⑥	a Ra : 0.19125μm	b Tear	c Collapse of Shape	d Burrs

Process	Milling Part	Milling Process	Tool	Cutting Speed (m/min)	Feed (mm/min)	ap (mm)	Pf (mm)
①	Overall	Contouring Line Long Flute High Efficiency Roughing	AE-TL-N 3x15	50 (5.300min ⁻¹)	600 (0,038mm/t)	11	0,3
②	Overall	Contouring Line Roughing	AE-LNBD-N R1x10x4	105 (16.800min ⁻¹)	1,500 (0,045mm/t)	0,25	0,25
③	Surface Plane	Frontal Milling Semi-roughing	AE-TL-N 3x15	50 (5.300min ⁻¹)	400 (0,025mm/t)	0,1	1
④	Overall	Contouring Line Semi-finishing	AE-LNBD-N R1x10x4	105 (16.800min ⁻¹)	1,500 (0,045mm/t)	0,25	0,25
⑤	Left Shape	Contouring Line High-precision Finishing	AE-LNBD-N R1x10x4	127 (20.160min ⁻¹)	750 (0,019mm/t)	0,03	0,03
⑥	Right Shape	Contouring Line High-precision Finishing	Conventional (Cr Coating) R1x10x4	127 (20.160min ⁻¹)	750 (0,019mm/t)	0,03	0,03



CUTTING DATA

Achieves consistent tool wear over time and machining accuracy compared to conventional products

Work materials of ① and ② are processed under the following cutting conditions

Tool	AE-LNBD-N R0,2X1X4	Conventional (Cr Coating)
Work Material	① Copper Tungsten ② Tough-Pitch Copper	
Milling Method	Contour and High Precision Finishing	
Cutting Speed	Vc=75m/min (60.000 min ⁻¹)	
Feed	Vf=600mm/min (0,005 mm/t)	
Depth of Cut	ap = 0,005mm Pf = 0,005mm	
Coolant	Non-Water Soluble	
Machine	Android II (HSK-E25)	

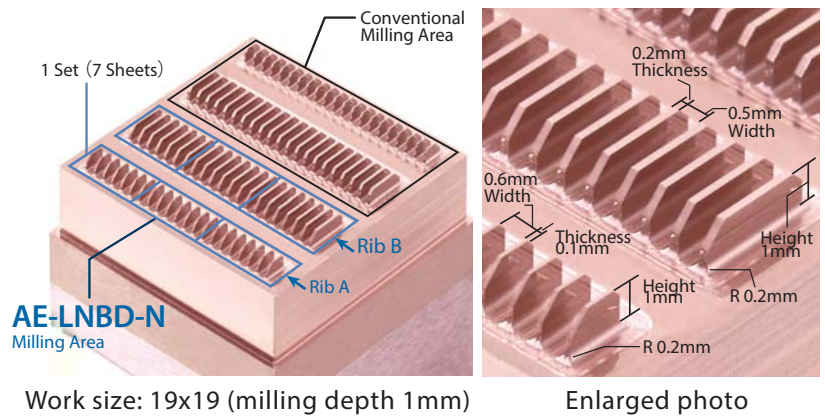

① Machining Copper Tungsten

■ Stable wear transition

52,1m
Wear comparison after milling 52,1 m

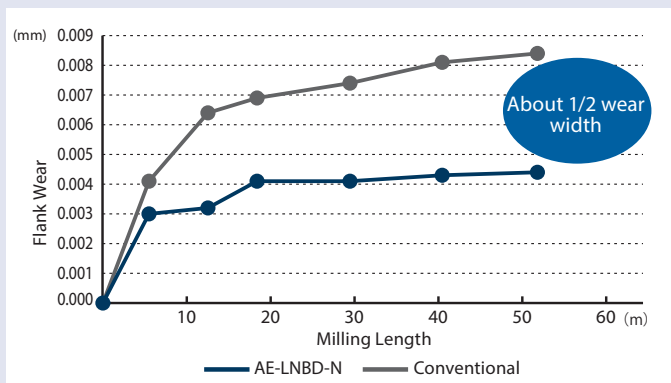
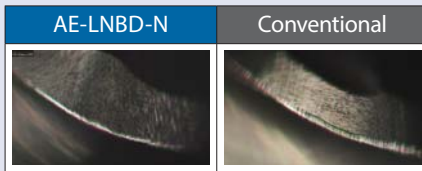

② Machining Tough-Pitch Copper

■ Good edge without burrs



■ Stable machining accuracy with little dimensional change

Evaluation method of cutting test

- ① Milling 1 set of tough-pitch copper ribs (7 sheets)
- ② Dimensional measurement by processing a copper alloy block for dimensional measurement of each set of ribs

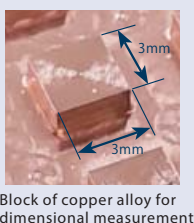

Cutting length of 1 set of ribs	
Rib A	Rib B
6,2 m/1set	11,1m/1set

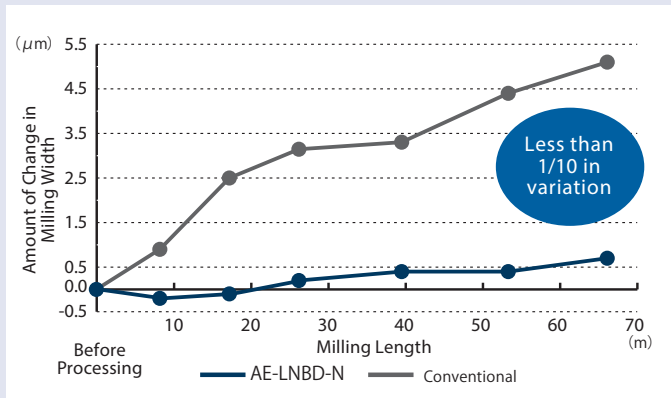

AE-LNBD-N

Milling | Solid carbide

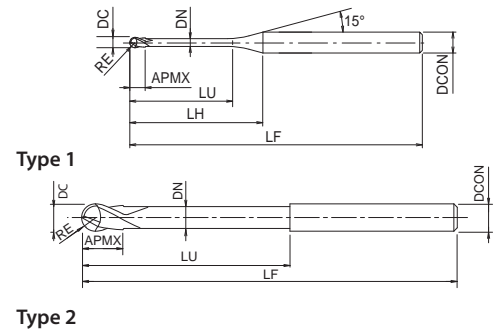
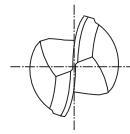
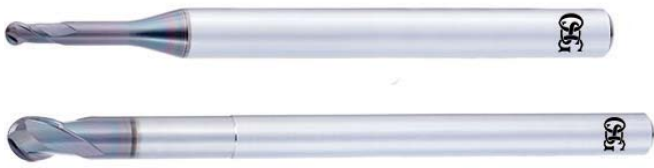

- First choice in quality and performance
- Carbide end mill with DLC coating
- For copper electrodes
- 2 flutes, long neck, ball nose
- 72 sizes

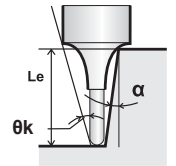

A

CARBIDE

DLC-IGUSS

30°

SHANK
h4

SHRINK
FIT

$R_{\alpha} \pm 0,002$
 $RE \leq 2$

$R_{\alpha} \pm 0,003$
 $0,2 < RE \leq 1,5$

$R_{\alpha} \pm 0,004$
 $1,5 < RE$

page 41

EDP	ZEFP	DC	RE	LU	LF	APMX	LH	DCON	DN	θk	Le (α=0,5°)	Le (α=1°)	Le (α=1,5°)	Le (α=2°)	Le (α=3°)	Type
3056370	2	0,1	0,05	0,3	45	0,08	7,6	4	0,09	14,52	0,3	0,31	0,32	0,33	0,36	1
3056371	2	0,1	0,05	0,5	45	0,08	7,8	4	0,09	14,07	0,53	0,56	0,59	0,62	0,67	1
3056372	2	0,15	0,075	0,3	45	0,12	7,5	4	0,135	14,55	0,3	0,31	0,32	0,33	0,35	1
3056373	2	0,15	0,075	0,5	45	0,12	7,7	4	0,135	14,12	0,52	0,55	0,58	0,6	0,65	1
3056374	2	0,15	0,075	1	45	0,12	8,2	4	0,135	13,29	1,05	1,1	1,14	1,18	1,27	1
3056375	2	0,2	0,1	0,3	45	0,16	7,4	4	0,19	14,59	0,3	0,31	0,32	0,33	0,34	1
3056376	2	0,2	0,1	0,5	45	0,16	7,6	4	0,19	14,12	0,53	0,56	0,58	0,61	0,66	1
3056377	2	0,2	0,1	1	45	0,16	8,1	4	0,19	13,28	1,06	1,11	1,15	1,19	1,28	1
3056378	2	0,2	0,1	1,5	45	0,16	8,6	4	0,19	12,53	1,58	1,65	1,7	1,76	1,9	1
3056379	2	0,3	0,15	0,6	45	0,24	7,5	4	0,285	14,02	0,63	0,65	0,68	0,7	0,75	1
3056380	2	0,3	0,15	1	45	0,24	7,9	4	0,285	13,33	1,05	1,09	1,13	1,17	1,25	1
3056381	2	0,3	0,15	1,5	45	0,24	8,4	4	0,285	12,56	1,57	1,63	1,68	1,74	1,87	1
3056382	2	0,3	0,15	2	45	0,24	8,9	4	0,285	11,87	2,09	2,16	2,24	2,32	2,49	1
3056383	2	0,4	0,2	1	45	0,3	7,7	4	0,38	13,38	1,04	1,08	1,11	1,15	1,23	1
3056384	2	0,4	0,2	2	45	0,3	8,7	4	0,38	11,87	2,08	2,15	2,22	2,3	2,47	1
3056385	2	0,4	0,2	3	45	0,3	9,7	4	0,38	10,66	3,12	3,22	3,33	3,45	3,71	1
3056386	2	0,4	0,2	4	45	0,3	10,7	4	0,38	9,68	4,15	4,29	4,44	4,6	4,95	1
3056387	2	0,5	0,25	1	45	0,4	7,6	4	0,475	13,43	1,03	1,07	1,1	1,13	1,2	1
3056388	2	0,5	0,25	2	45	0,4	8,6	4	0,475	11,87	2,07	2,14	2,21	2,28	2,45	1
3056389	2	0,5	0,25	3	45	0,4	9,6	4	0,475	10,63	3,11	3,21	3,32	3,43	3,69	1
3056390	2	0,5	0,25	4	45	0,4	10,6	4	0,475	9,63	4,14	4,28	4,42	4,58	4,93	1
3056391	2	0,5	0,25	5	45	0,4	11,6	4	0,475	8,79	5,18	5,35	5,53	5,73	6,18	1
3056392	2	0,6	0,3	1	45	0,5	7,3	4	0,55	13,5	1,02	1,05	1,07	1,1	1,17	1
3056393	2	0,6	0,3	2	45	0,5	8,3	4	0,55	11,89	2,06	2,12	2,18	2,25	2,41	1
3056394	2	0,6	0,3	3	45	0,5	9,3	4	0,55	10,62	3,09	3,19	3,29	3,4	3,66	1
3056395	2	0,6	0,3	4	45	0,5	10,3	4	0,55	9,59	4,12	4,26	4,4	4,55	4,9	1
3056396	2	0,6	0,3	5	45	0,5	11,3	4	0,55	8,74	5,16	5,33	5,51	5,7	6,14	1
3056397	2	0,6	0,3	6	45	0,5	12,3	4	0,55	8,02	6,19	6,4	6,62	6,85	7,39	1
3056398	2	0,8	0,4	2	45	0,6	8	4	0,75	11,87	2,05	2,11	2,17	2,24	2,39	1
3056399	2	0,8	0,4	3	45	0,6	9,1	4	0,75	10,53	3,09	3,18	3,28	3,39	3,63	1
3056400	2	0,8	0,4	4	45	0,6	10	4	0,75	9,46	4,12	4,25	4,39	4,54	4,88	1
3056401	2	0,8	0,4	6	45	0,6	12	4	0,75	7,86	6,19	6,39	6,61	6,84	7,36	1
3056402	2	0,8	0,4	8	45	0,6	14	4	0,75	6,72	8,25	8,53	8,82	9,14	9,85	1
3056403	2	1	0,5	2	45	0,8	7,6	4	0,95	11,85	2,05	2,1	2,16	2,22	2,37	1
3056404	2	1	0,5	3	45	0,8	8,6	4	0,95	10,44	3,08	3,17	3,27	3,37	3,61	1
3056405	2	1	0,5	4	45	0,8	9,6	4	0,95	9,32	4,12	4,24	4,38	4,52	4,85	1
3056406	2	1	0,5	5	45	0,8	10,6	4	0,95	8,42	5,15	5,31	5,49	5,67	6,1	1
3056407	2	1	0,5	6	45	0,8	11,6	4	0,95	7,68	6,18	6,38	6,59	6,82	7,34	1
3056408	2	1	0,5	8	45	0,8	13,6	4	0,95	6,52	8,25	8,52	8,81	9,12	9,83	1
3056409	2	1	0,5	10	45	0,8	15,6	4	0,95	5,67	10,32	10,66	11,03	11,42	12,31	1
3056410	2	1	0,5	12	45	0,8	17,6	4	0,95	5,01	12,39	12,8	13,24	13,72	14,8	1
3056411	2	1,5	0,75	4	45	1,2	8,8	4	1,45	8,8	4,18	4,33	4,46	4,6	4,92	1
3056412	2	1,5	0,75	6	45	1,2	10,8	4	1,45	7,09	6,27	6,47	6,68	6,9	7,4	1
3056413	2	1,5	0,75	12	55	1,2	16,8	4	1,45	4,46	12,48	12,89	13,33	13,8	14,86	1



AE-LNBD-N

Milling | Solid carbide

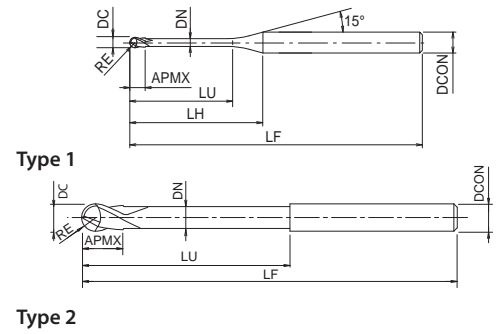
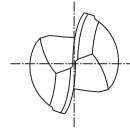

- First choice in quality and performance
- Carbide end mill with DLC coating
- For copper electrodes
- 2 flutes, long neck, ball nose
- 72 sizes

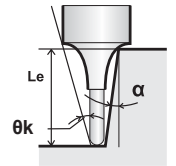

A
CARBIDE
DLC-IGUSS
30°
SHANK h4
SHRINK FIT
R ± 0,002 RE ≤ 2
R ± 0,003 0,2 < RE ≤ 1,5
R ± 0,004 1,5 < RE
page 41

EDP	ZEFP	DC	RE	LU	LF	APMX	LH	DCON	DN	θk	Le (α=0,5°)	Le (α=1°)	Le (α=1,5°)	Le (α=2°)	Le (α=3°)	Type
3056414	2	1,5	0,75	18	55	1,2	22,8	4	1,45	3,25	18,68	19,31	19,98	20,7	22,32	1
3056415	2	2	1	4	50	1,6	8,2	4	1,95	7,88	4,22	4,44	4,65	4,86	5,26	1
3056416	2	2	1	6	50	1,6	10,2	4	1,95	6,2	6,35	6,67	6,96	7,23	7,75	1
3056417	2	2	1	8	50	1,6	12,2	4	1,95	5,1	8,47	8,87	9,22	9,54	10,24	1
3056418	2	2	1	10	50	1,6	14,2	4	1,95	4,34	10,58	11,05	11,45	11,84	12,73	1
3056419	2	2	1	12	50	1,6	16,2	4	1,95	3,77	12,68	13,21	13,67	14,14	15,21	1
3056420	2	2	1	14	50	1,6	18,2	4	1,95	3,33	14,78	15,36	15,88	16,44	17,7	1
3056421	2	2	1	16	50	1,6	20,2	4	1,95	2,99	16,87	17,5	18,1	18,74	-	1
3056422	2	2	1	20	60	1,6	24,2	4	1,95	2,47	21,04	21,78	22,53	23,34	-	1
3056423	2	2	1	25	60	1,6	29,2	4	1,95	2,04	26,24	27,13	28,07	29,09	-	1
3056424	2	3	1,5	10	55	2,4	15,8	6	2,85	5,95	10,44	10,83	11,18	11,55	12,37	1
3056425	2	3	1,5	12	55	2,4	17,8	6	2,85	5,23	12,53	12,98	13,4	13,85	14,85	1
3056426	2	3	1,5	14	55	2,4	19,8	6	2,85	4,67	14,62	15,12	15,62	16,15	17,34	1
3056427	2	3	1,5	16	55	2,4	21,8	6	2,85	4,21	16,7	17,26	17,83	18,45	19,83	1
3056428	2	3	1,5	20	55	2,4	25,8	6	2,85	3,53	20,85	21,54	22,27	23,05	24,8	1
3056429	2	3	1,5	25	65	2,4	30,8	6	2,85	2,93	26,03	26,89	27,81	28,8	-	1
3056430	2	3	1,5	30	65	2,4	35,8	6	2,85	2,5	31,2	32,24	33,35	34,54	-	1
3056431	2	4	2	10	60	3,2	14	6	3,85	4,75	10,42	10,79	11,13	11,47	12,25	1
3056432	2	4	2	15	60	3,2	19	6	3,85	3,37	15,64	16,16	16,67	17,22	18,47	1
3056433	2	4	2	20	65	3,2	24	6	3,85	2,61	20,84	21,51	22,21	22,97	-	1
3056434	2	4	2	25	65	3,2	29	6	3,85	2,13	26,02	26,85	27,75	28,72	-	1
3056435	2	4	2	30	80	3,2	34	6	3,85	1,79	31,18	32,2	33,3	-	-	1
3056436	2	4	2	40	80	3,2	44	6	3,85	1,37	41,52	42,9	-	-	-	1
3056437	2	6	3	10	70	4,8	-	6	5,85	-	-	-	-	-	-	2
3056438	2	6	3	15	70	4,8	-	6	5,85	-	-	-	-	-	-	2
3056439	2	6	3	20	70	4,8	-	6	5,85	-	-	-	-	-	-	2
3056440	2	6	3	30	90	4,8	-	6	5,85	-	-	-	-	-	-	2
3056441	2	6	3	50	90	4,8	-	6	5,85	-	-	-	-	-	-	2

Milling | Solid carbide

CUTTING CONDITIONS

Milling | Endmills | Cutting conditions

AE-LNBD-N

Work Material		Wrought aluminium alloy A7075				Aluminium alloy casting · Die casting <Si 13%				Copper C1020 - C1100				Copper Tungsten W70% - Cu30%			
RE	LU (mm)	S (min ⁻¹)	F (mm/min)	Depth of cut (mm)		S (min ⁻¹)	F (mm/min)	Depth of cut (mm)		S (min ⁻¹)	F (mm/min)	Depth of cut (mm)		S (min ⁻¹)	F (mm/min)	Depth of cut (mm)	
				ap	pf			ap	pf			ap	pf			ap	pf
R0,05	0,3	50.000	293	0,005	0,01	43.800	257	0,005	0,01	38.400	225	0,005	0,01	32.000	120	0,005	0,008
R0,05	0,5	50.000	234	0,005	0,01	43.800	205	0,005	0,01	38.400	180	0,005	0,01	32.000	96	0,005	0,008
R0,075	0,3	50.000	335	0,008	0,02	43.800	293	0,008	0,02	38.400	257	0,008	0,02	32.000	137	0,008	0,015
R0,075	0,5	50.000	293	0,008	0,02	43.800	257	0,008	0,02	38.400	225	0,008	0,02	32.000	120	0,008	0,021
R0,075	1	50.000	234	0,005	0,01	43.800	205	0,005	0,01	38.400	180	0,005	0,01	32.000	96	0,005	0,011
R0,1	0,3	50.000	586	0,020	0,04	43.800	513	0,02	0,04	38.400	450	0,02	0,04	32.000	240	0,02	0,03
R0,1	0,5	50.000	586	0,020	0,04	43.800	513	0,02	0,04	38.400	450	0,02	0,04	32.000	240	0,02	0,03
R0,1	1	50.000	293	0,020	0,04	43.800	257	0,02	0,04	38.400	225	0,02	0,04	32.000	120	0,02	0,03
R0,1	1,5	50.000	293	0,020	0,04	43.800	257	0,02	0,04	38.400	225	0,02	0,04	32.000	120	0,02	0,03
R0,15	0,6	50.000	1.172	0,020	0,06	43.800	1.027	0,02	0,06	38.400	900	0,02	0,06	32.000	480	0,02	0,045
R0,15	1	50.000	879	0,020	0,06	43.800	770	0,02	0,06	38.400	675	0,02	0,06	32.000	360	0,02	0,045
R0,15	1,5	50.000	879	0,020	0,06	43.800	770	0,02	0,06	38.400	675	0,02	0,06	32.000	360	0,02	0,045
R0,15	2	50.000	879	0,020	0,06	43.800	770	0,02	0,06	38.400	675	0,02	0,06	32.000	360	0,02	0,045
R0,2	1	50.000	1.172	0,025	0,1	43.800	1.027	0,025	0,1	38.400	900	0,025	0,1	32.000	480	0,025	0,075
R0,2	2	41.300	860	0,025	0,1	37.000	771	0,025	0,1	32.400	675	0,025	0,1	27.000	360	0,025	0,075
R0,2	3	41.300	860	0,025	0,1	37.000	771	0,025	0,1	32.400	675	0,025	0,1	27.000	360	0,025	0,075
R0,2	4	41.300	860	0,01	0,06	37.000	771	0,01	0,06	32.400	675	0,01	0,06	27.000	360	0,01	0,045
R0,25	1	50.000	1.465	0,04	0,1	43.800	1.283	0,04	0,1	38.400	1.125	0,04	0,1	32.000	600	0,04	0,075
R0,25	2	50.000	1.172	0,04	0,1	43.800	1.027	0,04	0,1	38.400	900	0,04	0,1	32.000	480	0,04	0,075
R0,25	3	41.300	860	0,04	0,1	37.000	771	0,04	0,1	32.400	675	0,04	0,1	27.000	360	0,04	0,075
R0,25	4	41.300	860	0,04	0,1	37.000	771	0,04	0,1	32.400	675	0,04	0,1	27.000	360	0,04	0,075
R0,25	5	32.100	573	0,04	0,1	28.700	513	0,04	0,1	25.200	450	0,04	0,1	21.000	240	0,04	0,075
R0,3	1	50.000	2.930	0,09	0,12	43.800	2.566	0,09	0,12	38.400	2.250	0,09	0,12	32.000	1.440	0,09	0,12
R0,3	2	50.000	2.198	0,09	0,12	43.800	1.925	0,09	0,12	38.400	1.688	0,09	0,12	32.000	1.080	0,09	0,12
R0,3	3	46.000	1.199	0,09	0,12	41.000	1.068	0,09	0,12	36.000	938	0,09	0,12	30.000	600	0,09	0,12
R0,3	4	45.900	1.196	0,09	0,12	41.000	1.068	0,09	0,12	36.000	938	0,09	0,12	30.000	600	0,09	0,12
R0,3	5	45.900	1.196	0,09	0,12	41.000	1.068	0,09	0,12	36.000	938	0,09	0,12	30.000	600	0,09	0,12
R0,3	6	38.300	719	0,09	0,12	34.000	638	0,09	0,12	30.000	563	0,09	0,12	25.000	360	0,09	0,12
R0,4	2	41.300	2.152	0,12	0,16	37.000	1.928	0,12	0,16	32.400	1.688	0,12	0,16	27.000	1.080	0,12	0,16
R0,4	3	41.300	2.152	0,12	0,16	37.000	1.928	0,12	0,16	32.400	1.688	0,12	0,16	27.000	1.080	0,12	0,16
R0,4	4	41.300	2.152	0,12	0,16	37.000	1.928	0,12	0,16	32.400	1.688	0,12	0,16	27.000	1.080	0,12	0,16
R0,4	6	36.700	1.195	0,12	0,12	32.800	1.068	0,12	0,12	28.800	938	0,12	0,12	24.000	600	0,12	0,12
R0,4	8	33.700	719	0,12	0,12	30.100	642	0,12	0,12	26.400	563	0,12	0,12	22.000	360	0,12	0,12
R0,5	2	42.800	2.388	0,15	0,2	38.300	2.137	0,15	0,2	33.600	1.875	0,15	0,2	28.000	1.200	0,15	0,2
R0,5	3	42.800	2.388	0,15	0,2	38.300	2.137	0,15	0,2	33.600	1.875	0,15	0,2	28.000	1.200	0,15	0,2
R0,5	4	42.800	2.388	0,15	0,2	38.300	2.137	0,15	0,2	33.600	1.875	0,15	0,2	28.000	1.200	0,15	0,2
R0,5	5	32.100	1.433	0,15	0,2	28.700	1.281	0,15	0,2	25.200	1.125	0,15	0,2	21.000	720	0,15	0,2
R0,5	6	32.100	1.433	0,15	0,2	28.700	1.281	0,15	0,2	25.200	1.125	0,15	0,2	21.000	720	0,15	0,2
R0,5	8	32.100	1.433	0,15	0,15	28.700	1.281	0,15	0,15	25.200	1.125	0,15	0,15	21.000	720	0,15	0,15
R0,5	10	27.500	955	0,12	0,12	24.600	854	0,12	0,12	21.600	750	0,12	0,12	18.000	480	0,12	0,12
R0,5	12	27.500	955	0,12	0,12	24.600	854	0,12	0,12	21.600	750	0,12	0,12	18.000	480	0,12	0,12
R0,75	4	30.600	2.869	0,24	0,3	27.400	2.569	0,24	0,3	24.000	2.250	0,24	0,3	20.000	1.440	0,24	0,3
R0,75	6	27.500	2.387	0,24	0,3	24.600	2.135	0,24	0,3	21.600	1.875	0,24	0,3	18.000	1.200	0,24	0,3
R0,75	12	26.000	1.434	0,24	0,24	23.300	1.285	0,24	0,24	20.400	1.125	0,24	0,24	17.000	720	0,24	0,24
R0,75	18	19.900	957	0,18	0,18	17.800	856	0,18	0,18	15.600	750	0,18	0,18	13.000	480	0,18	0,18
R1	4	25.200	3.341	0,3	0,56	22.600	2.996	0,3	0,56	19.800	2.625	0,3	0,56	16.500	1.680	0,27	0,56
R1	6	25.200	3.341	0,3	0,56	22.600	2.996	0,3	0,56	19.800	2.625	0,3	0,56	16.500	1.680	0,27	0,56
R1	8	25.200	3.341	0,3	0,56	22.600	2.996	0,3	0,56	19.800	2.625	0,3	0,56	16.500	1.680	0,27	0,56
R1	10	21.400	2.388	0,3	0,56	19.200	2.143	0,3	0,56	16.800	1.875	0,3	0,56	14.000	1.200	0,27	0,56
R1	12	21.400	2.388	0,3	0,56	19.200	2.143	0,3	0,56	16.800	1.875	0,3	0,56	14.000	1.200	0,27	0,56
R1	14	21.400	2.388	0,3	0,56	19.200	2.143	0,3	0,56	16.800	1.875	0,3	0,56	14.000	1.200	0,27	0,56
R1	16	21.400	2.388	0,3	0,42	19.200	2.143	0,3	0,42	16.800	1.875	0,3	0,42	14.000	1.200	0,27	0,42
R1	20	16.800	1.194	0,3	0,42	15.000	1.066	0,3	0,42	13.200	938	0,3	0,42	11.000	600	0,27	0,42
R1	25	16.800	1.194	0,3	0,42	15.000	1.066	0,3	0,42	13.200	938	0,3	0,42	11.000	600	0,27	0,42
R1,5	10	18.400	2.875	0,4	0,84	16.400	2.563	0,4	0,84	14.400	2.250	0,4	0,84	12.000	1.440	0,36	0,84
R1,5	12	15.300	2.869	0,4	0,84	13.700	2.569	0,4	0,84	12.000	2.250	0,4	0,84	10.000	1.440	0,36	0,84
R1,5	14	15.300	2.869	0,4	0,84	13.700	2.569	0,4	0,84	12.000	2.250	0,4	0,84	10.000	1.440	0,36	0,84
R1,5	16	15.300	1.434	0,4	0,84	13.700	1.284	0,4	0,84	12.000	1.125	0,4	0,84	10.000	720	0,36	0,84
R1,5	20	15.300	1.434	0,4	0,84	13.700	1.284	0,4	0,84	12.000	1.125	0,4	0,84	10.000	720	0,36	0,84
R1,5	25	15.300	1.434	0,4	0,84	13.700	1.284	0,4	0,84	12.000	1.125	0,4	0,84	10.000	720	0,36	0,84
R1,5	30	13.800	1.199	0,4	0,84	12.300	1.068	0,4	0,84	10.800	938	0,4	0,84	9.000	600	0,36	0,84
R2	10	13.800	3.833	1,0	1,28	12.300	3.417	1	1,28	10.800	3.000	1,0	1,3	9.000	1.920	0,9	1,3
R2	15	13.800	2.875	1,0	1,28	12.300	2.563	1	1,28	10.800	2.250	1,0	1,3	9.000	1.440	0,9	1,3
R2	20	10.700	1.911	1,0	1,28	9.600	1.714	1	1,28	8.400	1.500	1,0	1,3	7.000	960	0,9	1,3
R2	25	10.700	1.911	1,0	1,28	9.600	1.714	1	1,28	8.400	1.500	1,0	1,3	7.000	960	0,9	1,3
R2	30	10.700	1.911	0,8	1,28	9.600	1.714	0,8	1,28	8.400	1.500	0,8	1,3	7.000	960	0,7	1,3
R2	40	7.700	1.204	0,7	1,28	6.800	1.063	0,7	1,28	6.000	938	0,7	1,3	5.000	600	0,6	1,3
R3	10	13.800	4.313	1,2	1,8	12.300	3.844	1,2	1,8	10.800	3.375	1,2	1,8	9.000	2.160	1,1	1,8
R3	15	13.800	4.313	1,2	1,8	12.300	3.844	1,2	1,8	10.800	3.375	1,2	1,8	9.000	2.160	1,1	1,8
R3	20	10.700	2.388	1,2	1,8	9.600	2.143										

KEY FEATURES: AE-CPR-N

High-efficiency finishing long neck radius type
Achieves high efficiency, long tool life and high precision machining!

Achieves high efficiency milling with 3-flute specification*

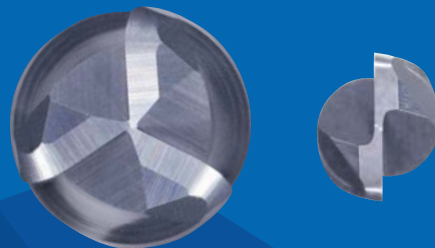

*2-flute specification for outer diameter less than 1 mm

Flat cutting edge specification

- Achieves higher precision machined surface quality



Flat cutting edge

*Excluding some sizes

Excellent cutting edge diameter accuracy and superior corner radius precision

- Excellent cutting edge diameter accuracy



(DC) up to $\varnothing 1$ 0 ~ -0,006
over $\varnothing 1$ 0 ~ -0,01

- Superior R precision



All sizes +/- 0,004

Abundant variations

- Available from outer diameter 0.2 mm to 6 mm with a wide variety of neck lengths



ACHIEVES HIGH EFFICIENCY AND LONG TOOL LIFE

Extension of tool life leads to waste reduction and contributes to resource conservation. Machining efficiency can be improved with the 3-flute specification for outer diameters of 1 mm or more. High-efficiency machining shortens machine operating time and reduces power consumption.

3-flute specification enables high-efficiency machining and long tool life

Tool	AE-CPR-N ø4 × R0,5 × 16 3 flute	Competitor 2 flute
Work Material	C1100	
Milling Method	Frontal Milling	
Cutting Speed	126m/min (10.000 min ⁻¹)	
Feed	4.200 mm/min (0,14 mm/t)	2.800 mm/min (0,14 mm/t)
Depth of Cut	ap = 0,3mm ae = 2,4mm	
Coolant	Water Soluble	
Machine	Horizontal Machining Center (HSK63)	

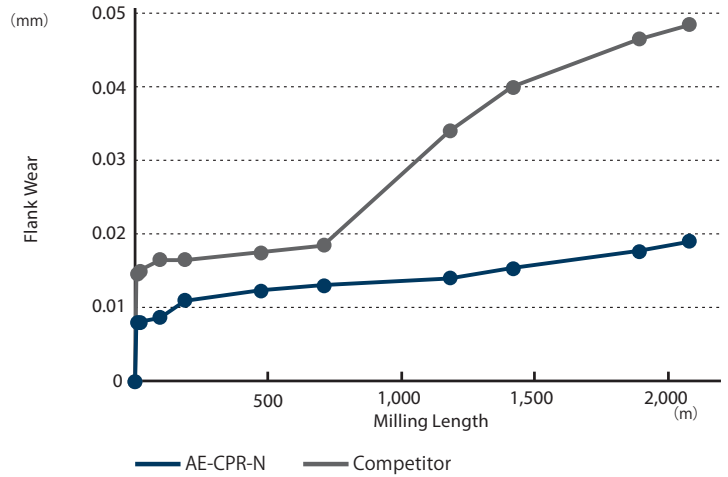

Wearing condition of the cutting edge after milling 2,079 m

	Wearing condition	Machining surface condition							
AE-CPR-N			<table border="1"> <tr> <th>Parameter</th> <th>Value (µm)</th> </tr> <tr> <td>Ra</td> <td>0.425</td> </tr> <tr> <td>Rz</td> <td>2.311</td> </tr> </table>	Parameter	Value (µm)	Ra	0.425	Rz	2.311
Parameter	Value (µm)								
Ra	0.425								
Rz	2.311								
Competitor			<table border="1"> <tr> <th>Parameter</th> <th>Value (µm)</th> </tr> <tr> <td>Ra</td> <td>0.422</td> </tr> <tr> <td>Rz</td> <td>2.858</td> </tr> </table>	Parameter	Value (µm)	Ra	0.422	Rz	2.858
Parameter	Value (µm)								
Ra	0.422								
Rz	2.858								

Milling | Solid carbide



CUTTING DATA

Stable wear transition even at $\phi 0,5$

Tool	AE-CPR-N 0,5 X R 0,1 X 3
Work Material	C1100
Milling Method	Frontal Milling
Cutting Speed	55m/min (35.000 min ⁻¹)
Feed	640mm/min (0,01 mm/t)
Depth of Cut	ap = 0,05mm ae = 0,25mm
Coolant	Water Soluble
Machine	Vertical Machining Center

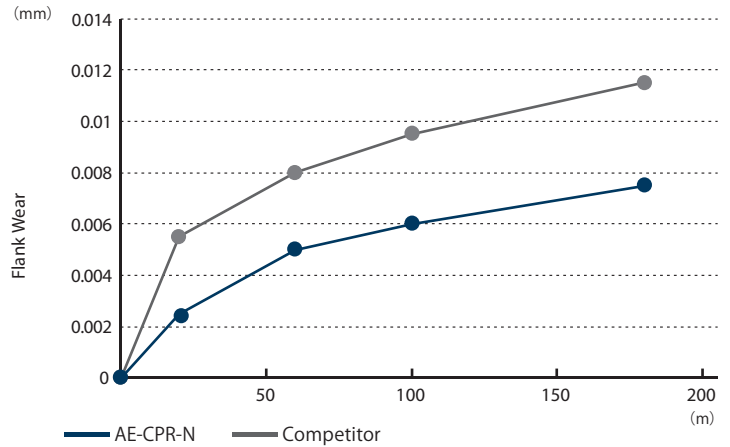

DLC coated end mill lineup for non-ferrous metals compatible with copper electrode applications

Scan code for product details



Standard specification suitable for non-ferrous material processing

DLC-SUPER HARD Coating

Short
AE-TS-N
1,5 x D cutting length



Long
AE-TL-N
3 x D / 5 x D cutting length



High performance type that supports a wide range of applications

DLC-SUPER HARD Coating

Short
AE-VTS-N
1,5 x D cutting length



For Deep Side Milling
AE-VTFE-N
2,5 x D cutting length



PXM Exchangeable Head End Mill

PXAL
1 x D cutting length



CUTTING DATA

Milling copper electrodes with high efficiency and precision

Tool	AE-CPR-N 1 X R0,2 X 10	Conventional 2 flute*	Competitor 2 flute
Work Material	Tough-Pitch Copper (C1100)		
Milling Method	Contour and High Precision Finishing		
Cutting Speed	56,5m/min (18.000 min ⁻¹)		
Feed	660mm/min (0,012mm/t)	360mm/min (0,01mm/t)	430mm/min (0,012mm/t)
Depth of Cut	ap = 0,025mm ae = 0,03mm		
Coolant	Water Soluble		
Machine	Vertical Machining Center		

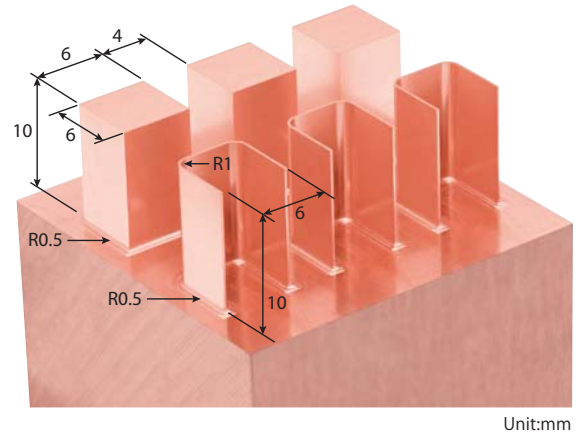

*Coated carbide end mill for steel (radius type)

Good milling accuracy and good processing shape

① Rib

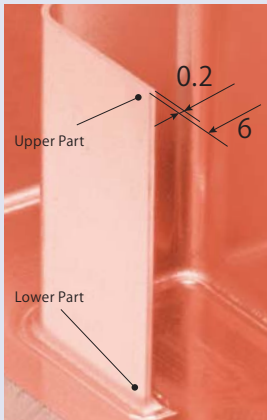

Rib width (target value: 0.2 mm)

Measurement Position	Measured value of machined surface		
	AE-CPR-N	Conventional	Competitor
Upper Part	0,2003mm	0,1946mm	0,2138mm
Lower Part	0,2008mm	0,1953mm	0,2128mm
Condition of Machined Surface			

② Vertex

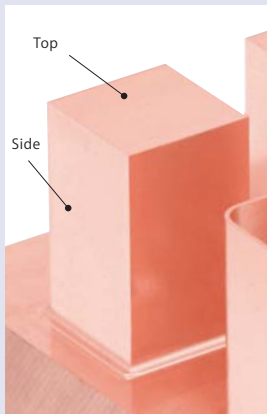

Surface roughness

Measurement Position	Measured value of machined surface		
	AE-CPR-N	Conventional	Competitor
Top	Ra : 0,052µm Rz : 0,664µm	Ra : 0,075µm Rz : 1,390µm	Ra : 0,075µm Rz : 0,563µm
Side	Ra : 0,173µm Rz : 1,279µm	Ra : 0,164µm Rz : 1,239µm	Ra : 0,232µm Rz : 1,438µm
Processing Shape			
The AE-CPR-N exhibited minimal collapse in shape			



AE-CPR-N NEW

Milling | Solid carbide

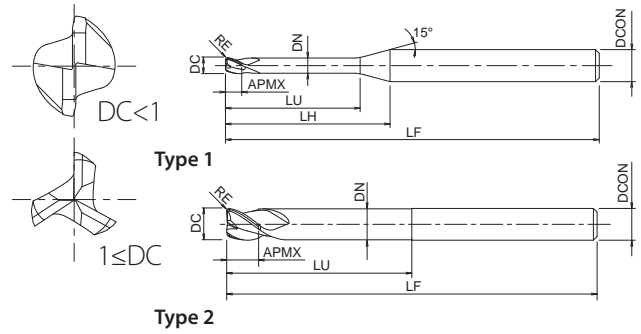

- First choice in quality and performance
- DLC-IGUSS Coated Carbide End Mill for Copper Electrodes
- Long neck radius type for high-efficiency finishing
- 2-3 flutes
- 144 sizes

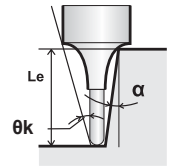

A
CARBIDE
DLC-IGUSS
38°
SHANK h4
SHRINK FIT
D≤1 0~0.006
1-D 0~0.01
page 50

EDP	ZEFP	DC	RE	LU	LF	APMX	LH	DCON	DN	θk	Le (α=0,5°)	Le (α=1°)	Le (α=1,5°)	Le (α=2°)	Le (α=3°)	Type
8557646	2	0,2	0,05	0,4	45	0,2	7,5	4	0,175	14,28°	0,41	0,43	0,45	0,47	0,51	1
8557647	2	0,2	0,05	0,6	45	0,2	7,7	4	0,175	13,92°	0,62	0,65	0,68	0,7	0,75	1
8557648	2	0,2	0,05	1	45	0,2	8,1	4	0,175	13,26°	1,04	1,08	1,12	1,16	1,25	1
8557649	2	0,2	0,05	1,5	45	0,2	8,6	4	0,175	12,51°	1,56	1,62	1,68	1,74	1,87	1
8557650	2	0,3	0,05	0,6	45	0,3	7,5	4	0,275	13,9°	0,62	0,65	0,68	0,7	0,75	1
8557651	2	0,3	0,05	1	45	0,3	7,9	4	0,275	13,22°	1,04	1,08	1,12	1,16	1,25	1
8557652	2	0,3	0,05	1,5	45	0,3	8,4	4	0,275	12,45°	1,56	1,62	1,68	1,74	1,87	1
8557653	2	0,3	0,05	2	45	0,3	8,9	4	0,275	11,77°	2,08	2,15	2,23	2,31	2,5	1
8557654	2	0,4	0,02	0,8	45	0,4	7,5	4	0,37	13,47°	0,83	0,86	0,9	0,93	1	1
8557655	2	0,4	0,02	2	45	0,4	8,7	4	0,37	11,68°	2,08	2,15	2,23	2,31	2,5	1
8557656	2	0,4	0,05	0,8	45	0,4	7,5	4	0,37	13,52°	0,83	0,86	0,89	0,92	1	1
8557657	2	0,4	0,05	1,2	45	0,4	7,9	4	0,37	12,86°	1,25	1,29	1,34	1,38	1,49	1
8557658	2	0,4	0,05	2	45	0,4	8,7	4	0,37	11,71°	2,08	2,15	2,22	2,3	2,49	1
8557659	2	0,4	0,05	3	45	0,4	9,7	4	0,37	10,53°	3,11	3,22	3,33	3,45	3,73	1
8557660	2	0,4	0,05	4	45	0,4	10,7	4	0,37	9,57°	4,14	4,29	4,44	4,6	4,97	1
8557661	2	0,4	0,1	0,8	45	0,4	7,5	4	0,37	13,6°	0,83	0,86	0,89	0,92	0,98	1
8557662	2	0,4	0,1	1,2	45	0,4	7,9	4	0,37	12,93°	1,24	1,29	1,33	1,38	1,48	1
8557663	2	0,4	0,1	2	45	0,4	8,7	4	0,37	11,77°	2,07	2,14	2,22	2,3	2,48	1
8557664	2	0,4	0,1	3	45	0,4	9,7	4	0,37	10,58°	3,11	3,21	3,33	3,45	3,72	1
8557665	2	0,4	0,1	4	45	0,4	10,7	4	0,37	9,61°	4,14	4,28	4,43	4,6	4,96	1
8557666	2	0,5	0,05	1	45	0,5	7,5	4	0,45	13,16°	1,03	1,06	1,1	1,14	1,23	1
8557667	2	0,5	0,05	2	45	0,5	8,5	4	0,45	11,65°	2,06	2,13	2,21	2,29	2,47	1
8557668	2	0,5	0,05	3	45	0,5	9,5	4	0,45	10,45°	3,1	3,2	3,32	3,44	3,72	1
8557669	2	0,5	0,05	4	45	0,5	10,5	4	0,45	9,48°	4,13	4,27	4,43	4,59	4,96	1
8557670	2	0,5	0,05	5	45	0,5	11,5	4	0,45	8,67°	5,16	5,34	5,53	5,74	6,2	1
8557671	2	0,5	0,1	1	45	0,5	7,5	4	0,45	13,23°	1,03	1,06	1,1	1,13	1,22	1
8557672	2	0,5	0,1	2	45	0,5	8,5	4	0,45	11,71°	2,06	2,13	2,2	2,28	2,46	1
8557673	2	0,5	0,1	3	45	0,5	9,5	4	0,45	10,5°	3,1	3,2	3,31	3,43	3,7	1
8557674	2	0,5	0,1	4	45	0,5	10,5	4	0,45	9,52°	4,13	4,27	4,42	4,58	4,95	1
8557675	2	0,5	0,1	5	45	0,5	11,5	4	0,45	8,7°	5,16	5,34	5,53	5,73	6,19	1
8557676	2	0,6	0,05	1,2	45	0,6	7,5	4	0,55	12,77°	1,24	1,28	1,32	1,37	1,48	1
8557677	2	0,6	0,05	2	45	0,6	8,3	4	0,55	11,58°	2,06	2,13	2,21	2,29	2,47	1
8557678	2	0,6	0,05	4	45	0,6	10,3	4	0,55	9,38°	4,13	4,27	4,43	4,59	4,96	1
8557679	2	0,6	0,05	6	45	0,6	12,3	4	0,55	7,87°	6,2	6,41	6,64	6,89	7,45	1
8557680	2	0,6	0,1	1,2	45	0,6	7,5	4	0,55	12,84°	1,23	1,27	1,32	1,36	1,47	1
8557681	2	0,6	0,1	2	45	0,6	8,3	4	0,55	11,64°	2,06	2,13	2,2	2,28	2,46	1
8557682	2	0,6	0,1	3	45	0,6	9,3	4	0,55	10,41°	3,1	3,2	3,31	3,43	3,7	1
8557683	2	0,6	0,1	4	45	0,6	10,3	4	0,55	9,42°	4,13	4,27	4,42	4,58	4,95	1
8557684	2	0,6	0,1	6	45	0,6	12,3	4	0,55	7,9°	6,2	6,41	6,64	6,88	7,43	1
8557685	2	0,6	0,2	1,2	45	0,6	7,5	4	0,55	12,99°	1,23	1,27	1,31	1,35	1,44	1
8557686	2	0,6	0,2	4	45	0,6	10,3	4	0,55	9,5°	4,13	4,26	4,41	4,57	4,92	1
8557687	2	0,8	0,05	1,6	45	0,8	7,6	4	0,75	12°	1,65	1,71	1,77	1,83	1,98	1
8557688	2	0,8	0,05	4	45	0,8	10	4	0,75	9,16°	4,13	4,27	4,43	4,59	4,96	1
8557689	2	0,8	0,05	6	45	0,8	12	4	0,75	7,65°	6,2	6,41	6,64	6,89	7,45	1
8557690	2	0,8	0,05	8	45	0,8	14	4	0,75	6,56°	8,27	8,55	8,86	9,19	9,93	1
8557691	2	0,8	0,1	1,6	45	0,8	7,6	4	0,75	12,07°	1,65	1,7	1,76	1,82	1,96	1

Milling | Solid carbide



AE-CPR-N NEW

Milling | Solid carbide

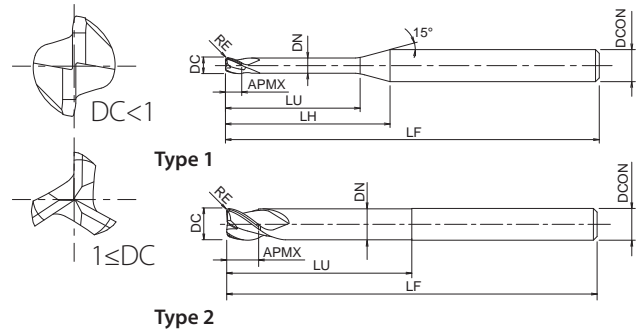

- First choice in quality and performance
- DLC-IGUSS Coated Carbide End Mill for Copper Electrodes
- Long neck radius type for high-efficiency finishing
- 2-3 flutes
- 144 sizes

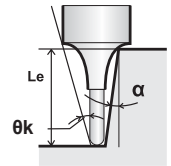

A
CARBIDE
DLC-IGUSS
38°
SHANK h4
SHRINK FIT
D≤1 0~-0.006
1-D 0~-0.01
 page 50

EDP	ZEFP	DC	RE	LU	LF	APMX	LH	DCON	DN	θk	Le (α=0,5°)	Le (α=1°)	Le (α=1,5°)	Le (α=2°)	Le (α=3°)	Type
8557692	2	0,8	0,1	4	45	0,8	10	4	0,75	9,2°	4,13	4,27	4,42	4,58	4,95	1
8557693	2	0,8	0,1	6	45	0,8	12	4	0,75	7,67°	6,2	6,41	6,64	6,88	7,43	1
8557694	2	0,8	0,1	8	45	0,8	14	4	0,75	6,58°	8,26	8,55	8,85	9,18	9,92	1
8557695	3	1	0,02	2	45	1	7,6	4	0,95	11,19°	2,06	2,14	2,21	2,29	2,48	1
8557696	3	1	0,02	3	45	1	8,6	4	0,95	9,92°	3,1	3,21	3,32	3,44	3,72	1
8557697	3	1	0,1	2	45	1	7,6	4	0,95	11,3°	2,06	2,13	2,2	2,28	2,46	1
8557698	3	1	0,1	3	45	1	8,6	4	0,95	10°	3,1	3,2	3,31	3,43	3,7	1
8557699	3	1	0,1	4	45	1	9,6	4	0,95	8,97°	4,13	4,27	4,42	4,58	4,95	1
8557700	3	1	0,1	5	45	1	10,6	4	0,95	8,13°	5,16	5,34	5,53	5,73	6,19	1
8557701	3	1	0,1	6	45	1	11,6	4	0,95	7,43°	6,2	6,41	6,64	6,88	7,43	1
8557702	3	1	0,1	8	45	1	13,6	4	0,95	6,34°	8,26	8,55	8,85	9,18	9,92	1
8557703	3	1	0,1	10	45	1	15,6	4	0,95	5,53°	10,33	10,69	11,07	11,48	12,41	1
8557704	3	1	0,2	2	45	1	7,6	4	0,95	11,43°	2,06	2,12	2,19	2,27	2,44	1
8557705	3	1	0,2	3	45	1	8,6	4	0,95	10,11°	3,09	3,19	3,3	3,42	3,68	1
8557706	3	1	0,2	4	45	1	9,6	4	0,95	9,06°	4,13	4,26	4,41	4,57	4,92	1
8557707	3	1	0,2	5	45	1	10,6	4	0,95	8,2°	5,16	5,33	5,52	5,72	6,17	1
8557708	3	1	0,2	6	45	1	11,6	4	0,95	7,49°	6,19	6,4	6,63	6,87	7,41	1
8557709	3	1	0,2	8	45	1	13,6	4	0,95	6,39°	8,26	8,54	8,84	9,17	9,9	1
8557710	3	1	0,2	10	45	1	15,6	4	0,95	5,56°	10,33	10,68	11,06	11,47	12,38	1
8557711	3	1	0,3	2	45	1	7,6	4	0,95	11,57°	2,06	2,12	2,18	2,25	2,41	1
8557712	3	1	0,3	3	45	1	8,6	4	0,95	10,22°	3,09	3,19	3,29	3,4	3,66	1
8557713	3	1,5	0,3	3	45	1,5	7,8	4	1,45	9,48°	3,15	3,28	3,4	3,52	3,78	1
8557714	3	1,5	0,5	3	45	1,5	7,8	4	1,45	9,71°	3,14	3,27	3,38	3,49	3,73	1
8557715	3	1,5	0,5	10	45	1,5	14,8	4	1,45	5°	10,42	10,77	11,14	11,54	12,43	1
8557716	3	1,5	0,5	12	60	1,5	16,8	4	1,45	4,39°	12,49	12,91	13,35	13,84	14,92	1
8557717	3	1,5	0,5	20	60	1,5	24,8	4	1,45	2,95°	20,76	21,46	22,22	23,04	-	1
8557718	3	2	0,1	4	50	2	8,2	4	1,95	7,07°	4,28	4,55	4,79	5,03	5,48	1
8557719	3	2	0,1	6	50	2	10,2	4	1,95	5,68°	6,41	6,76	7,08	7,37	7,97	1
8557720	3	2	0,1	8	50	2	12,2	4	1,95	4,74°	8,52	8,95	9,32	9,67	10,45	1
8557721	3	2	0,1	10	50	2	14,2	4	1,95	4,07°	10,63	11,12	11,54	11,97	12,94	1
8557722	3	2	0,1	15	50	2	19,2	4	1,95	3,01°	15,87	16,49	17,09	17,72	19,15	1
8557723	3	2	0,1	16	60	2	20,2	4	1,95	2,86°	16,91	17,56	18,19	18,87	-	1
8557724	3	2	0,1	20	60	2	24,2	4	1,95	2,38°	21,08	21,84	22,63	23,47	-	1
8557725	3	2	0,2	4	50	2	8,2	4	1,95	7,15°	4,28	4,53	4,78	5,01	5,46	1
8557726	3	2	0,2	10	50	2	14,2	4	1,95	4,1°	10,62	11,11	11,53	11,96	12,91	1
8557727	3	2	0,2	16	60	2	20,2	4	1,95	2,87°	16,91	17,56	18,18	18,86	-	1
8557728	3	2	0,2	20	60	2	24,2	4	1,95	2,39°	21,08	21,84	22,62	23,46	-	1
8557729	3	2	0,3	4	50	2	8,2	4	1,95	7,24°	4,27	4,52	4,76	4,99	5,43	1
8557730	3	2	0,3	6	50	2	10,2	4	1,95	5,79°	6,39	6,74	7,05	7,34	7,92	1
8557731	3	2	0,3	8	50	2	12,2	4	1,95	4,82°	8,51	8,93	9,3	9,64	10,4	1
8557732	3	2	0,3	10	50	2	14,2	4	1,95	4,13°	10,62	11,1	11,52	11,94	12,89	1
8557733	3	2	0,3	15	50	2	19,2	4	1,95	3,04°	15,86	16,48	17,06	17,69	19,11	1
8557734	3	2	0,3	16	60	2	20,2	4	1,95	2,89°	16,9	17,55	18,17	18,84	-	1
8557735	3	2	0,3	20	60	2	24,2	4	1,95	2,4°	21,07	21,83	22,61	23,44	-	1
8557736	3	2,5	0,5	5	55	2,5	8,1	4	2,4	5,61°	5,28	5,54	5,79	6,03	6,49	1
8557737	3	2,5	0,5	20	55	2,5	23,1	4	2,4	1,9°	20,97	21,7	22,46	-	-	1

Milling | Solid carbide



AE-CPR-N NEW

Milling | Solid carbide

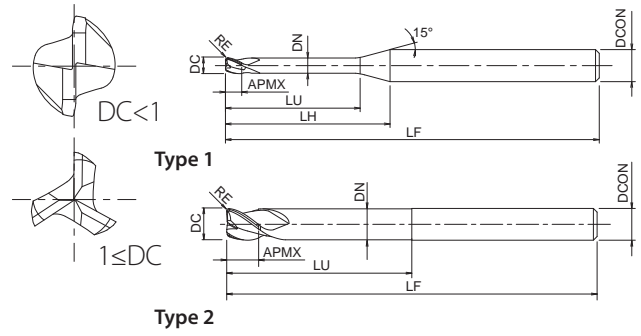

- First choice in quality and performance
- DLC-IGUSS Coated Carbide End Mill for Copper Electrodes
- Long neck radius type for high-efficiency finishing
- 2-3 flutes
- 144 sizes

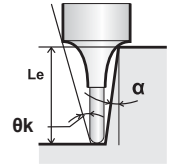
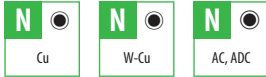

Milling | Solid carbide

EDP	ZEFP	DC	RE	LU	LF	APMX	LH	DCON	DN	θk	Le (α=0,5°)	Le (α=1°)	Le (α=1,5°)	Le (α=2°)	Le (α=3°)	Type
8557738	3	3	0,2	6	55	3	11,8	6	2,85	7,34°	6,31	6,6	6,88	7,14	7,7	1
8557739	3	3	0,2	12	55	3	17,8	6	2,85	4,86°	12,59	13,07	13,54	14,04	15,16	1
8557740	3	3	0,2	18	55	3	23,8	6	2,85	3,64°	18,83	19,49	20,19	20,94	22,62	1
8557741	3	3	0,2	21	70	3	26,8	6	2,85	3,23°	21,94	22,7	23,51	24,39	26,35	1
8557742	3	3	0,2	24	70	3	29,8	6	2,85	2,9°	25,04	25,91	26,84	27,84	-	1
8557743	3	3	0,3	6	55	3	11,8	6	2,85	7,4°	6,31	6,6	6,87	7,12	7,68	1
8557744	3	3	0,3	8	55	3	13,8	6	2,85	6,32°	8,4	8,77	9,09	9,42	10,17	1
8557745	3	3	0,3	12	55	3	17,8	6	2,85	4,89°	12,58	13,07	13,53	14,02	15,14	1
8557746	3	3	0,3	20	55	3	25,8	6	2,85	3,37°	20,9	21,62	22,39	23,22	25,08	1
8557747	3	3	0,5	6	55	3	11,8	6	2,85	7,52°	6,3	6,58	6,84	7,1	7,63	1
8557748	3	3	0,5	12	55	3	17,8	6	2,85	4,94°	12,57	13,05	13,51	13,99	15,09	1
8557749	3	3	0,5	15	55	3	20,8	6	2,85	4,22°	15,7	16,26	16,83	17,44	18,82	1
8557750	3	3	0,5	18	55	3	23,8	6	2,85	3,68°	18,82	19,47	20,16	20,89	22,55	1
8557751	3	3	0,5	21	70	3	26,8	6	2,85	3,26°	21,93	22,68	23,48	24,34	26,28	1
8557752	3	3	0,5	25	70	3	30,8	6	2,85	2,83°	26,07	26,96	27,91	28,94	-	1
8557753	3	3	0,5	30	70	3	35,8	6	2,85	2,43°	31,24	32,31	33,46	34,69	-	1
8557754	3	4	0,2	8	60	4	12	6	3,85	4,86°	8,41	8,77	9,11	9,44	10,19	1
8557755	3	4	0,2	16	60	4	20	6	3,85	2,9°	16,75	17,35	17,97	18,64	-	1
8557756	3	4	0,2	20	60	4	24	6	3,85	2,41°	20,9	21,63	22,4	23,24	-	1
8557757	3	4	0,2	24	60	4	28	6	3,85	2,07°	25,04	25,91	26,84	27,84	-	1
8557758	3	4	0,2	28	75	4	32	6	3,85	1,81°	29,18	30,19	31,27	-	-	1
8557759	3	4	0,2	32	75	4	36	6	3,85	1,61°	33,31	34,47	35,7	-	-	1
8557760	3	4	0,3	8	60	4	12	6	3,85	4,9°	8,4	8,77	9,09	9,42	10,17	1
8557761	3	4	0,3	20	60	4	24	6	3,85	2,42°	20,9	21,62	22,39	23,22	-	1
8557762	3	4	0,5	8	60	4	12	6	3,85	4,98°	8,39	8,75	9,07	9,4	10,12	1
8557763	3	4	0,5	12	60	4	16	6	3,85	3,7°	12,57	13,05	13,51	13,99	15,09	1
8557764	3	4	0,5	16	60	4	20	6	3,85	2,94°	16,74	17,33	17,94	18,59	-	1
8557765	3	4	0,5	20	60	4	24	6	3,85	2,44°	20,89	21,61	22,37	23,19	-	1
8557766	3	4	0,5	24	60	4	28	6	3,85	2,09°	25,03	25,89	26,81	27,79	-	1
8557767	3	4	0,5	25	60	4	29	6	3,85	2,02°	26,07	26,96	27,91	28,94	-	1
8557768	3	4	0,5	28	75	4	32	6	3,85	1,82°	29,17	30,17	31,24	-	-	1
8557769	3	4	0,5	32	75	4	36	6	3,85	1,62°	33,3	34,45	35,67	-	-	1
8557770	3	4	1	8	60	4	12	6	3,85	5,19°	8,37	8,71	9,02	9,32	10	1
8557771	3	4	1	16	60	4	20	6	3,85	3,02°	16,72	17,3	17,89	18,52	19,95	1
8557772	3	4	1	24	60	4	28	6	3,85	2,13°	25,02	25,85	26,75	27,72	-	1
8557773	3	4	1	28	75	4	32	6	3,85	1,85°	29,15	30,13	31,19	-	-	1
8557774	3	4	1	32	75	4	36	6	3,85	1,64°	33,29	34,41	35,62	-	-	1
8557775	3	6	0,1	12	60	6	-	6	5,85	-	-	-	-	-	-	2
8557776	3	6	0,1	24	60	6	-	6	5,85	-	-	-	-	-	-	2
8557777	3	6	0,2	12	60	6	-	6	5,85	-	-	-	-	-	-	2
8557778	3	6	0,2	24	60	6	-	6	5,85	-	-	-	-	-	-	2
8557779	3	6	0,2	32	80	6	-	6	5,85	-	-	-	-	-	-	2
8557780	3	6	0,2	48	80	6	-	6	5,85	-	-	-	-	-	-	2
8557781	3	6	0,5	12	60	6	-	6	5,85	-	-	-	-	-	-	2
8557782	3	6	0,5	24	60	6	-	6	5,85	-	-	-	-	-	-	2
8557783	3	6	0,5	30	60	6	-	6	5,85	-	-	-	-	-	-	2

AE-CPR-N NEW

Milling | Solid carbide

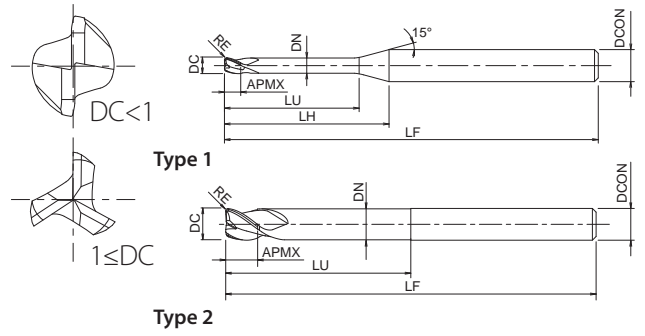

- First choice in quality and performance
- DLC-IGUSS Coated Carbide End Mill for Copper Electrodes
- Long neck radius type for high-efficiency finishing
- 2-3 flutes
- 144 sizes

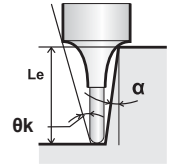

A
CARBIDE
DLC-IGUSS
38°
SHANK h4
SHRINK FIT
 $D \leq 1$
0~-0.006
 $1 < D$
0~-0.01
page 50

EDP	ZEFP	DC	RE	LU	LF	APMX	LH	DCON	DN	θ_k	Le ($\alpha=0,5^\circ$)	Le ($\alpha=1^\circ$)	Le ($\alpha=1,5^\circ$)	Le ($\alpha=2^\circ$)	Le ($\alpha=3^\circ$)	Type
8557784	3	6	0,5	32	80	6	-	6	5,85	-	-	-	-	-	-	2
8557785	3	6	0,5	48	80	6	-	6	5,85	-	-	-	-	-	-	2
8557786	3	6	1	12	60	6	-	6	5,85	-	-	-	-	-	-	2
8557787	3	6	1	24	60	6	-	6	5,85	-	-	-	-	-	-	2
8557788	3	6	1	32	80	6	-	6	5,85	-	-	-	-	-	-	2
8557789	3	6	1	48	80	6	-	6	5,85	-	-	-	-	-	-	2



CUTTING CONDITIONS

Milling | Endmills | Cutting conditions

AE-CPR-N

Work Material			Copper C1020 - C1100				Copper Tungsten W70% - Cu30%				Wrought aluminium alloy A7075				Aluminium alloy casting • Die casting <SI 13%			
DC	RE	LU (mm)	S (min ⁻¹)	F (mm/min)	Depth of cut (mm)		S (min ⁻¹)	F (mm/min)	Depth of cut (mm)		S (min ⁻¹)	F (mm/min)	Depth of cut (mm)		S (min ⁻¹)	F (mm/min)	Depth of cut (mm)	
					ap	ae			ap	ae			ap	ae			ap	ae
0,2	R0,05	0,4	40.000	400	0,03	0,06	40.000	360	0,024	0,06	40.000	400	0,03	0,06	40.000	400	0,03	0,06
0,2	R0,05	0,6	40.000	360	0,024	0,06	40.000	320	0,019	0,06	40.000	360	0,024	0,06	40.000	360	0,024	0,06
0,2	R0,05	1	40.000	280	0,019	0,06	40.000	250	0,015	0,06	40.000	280	0,019	0,06	40.000	280	0,019	0,06
0,2	R0,05	1,5	40.000	180	0,015	0,06	40.000	160	0,012	0,06	40.000	180	0,015	0,06	40.000	180	0,015	0,06
0,3	R0,05	0,6	40.000	480	0,03	0,12	40.000	430	0,024	0,12	40.000	480	0,03	0,12	40.000	480	0,03	0,12
0,3	R0,05	1	40.000	430	0,023	0,12	40.000	380	0,018	0,12	40.000	430	0,023	0,12	40.000	430	0,023	0,12
0,3	R0,05	1,5	40.000	360	0,019	0,12	40.000	320	0,015	0,12	40.000	360	0,019	0,12	40.000	360	0,019	0,12
0,3	R0,05	2	40.000	290	0,016	0,12	40.000	260	0,013	0,12	40.000	290	0,016	0,12	40.000	290	0,016	0,12
0,4	R0,02	0,8	40.000	640	0,01	0,22	40.000	580	0,008	0,22	40.000	640	0,01	0,22	40.000	640	0,01	0,22
0,4	R0,02	2	40.000	520	0,006	0,22	35.000	410	0,005	0,22	40.000	520	0,006	0,22	40.000	520	0,006	0,22
0,4	R0,05	0,8	40.000	640	0,03	0,18	40.000	580	0,024	0,18	40.000	640	0,03	0,18	40.000	640	0,03	0,18
0,4	R0,05	1,2	40.000	600	0,024	0,18	40.000	540	0,019	0,18	40.000	600	0,024	0,18	40.000	600	0,024	0,18
0,4	R0,05	2	40.000	520	0,019	0,18	35.000	410	0,015	0,18	40.000	520	0,019	0,18	40.000	520	0,019	0,18
0,4	R0,05	3	30.000	370	0,015	0,18	25.000	300	0,012	0,18	39.000	480	0,015	0,18	34.500	430	0,015	0,18
0,4	R0,05	4	25.000	240	0,013	0,18	20.000	190	0,01	0,18	32.500	310	0,013	0,18	28.750	280	0,013	0,18
0,4	R0,1	0,8	40.000	640	0,06	0,12	40.000	580	0,048	0,12	40.000	640	0,06	0,12	40.000	640	0,06	0,12
0,4	R0,1	1,2	40.000	600	0,049	0,12	40.000	540	0,039	0,12	40.000	600	0,049	0,12	40.000	600	0,049	0,12
0,4	R0,1	2	40.000	520	0,038	0,12	35.000	410	0,03	0,12	40.000	520	0,038	0,12	40.000	520	0,038	0,12
0,4	R0,1	3	30.000	370	0,031	0,12	25.000	300	0,025	0,12	39.000	480	0,031	0,12	34.500	430	0,031	0,12
0,4	R0,1	4	25.000	240	0,027	0,12	20.000	190	0,022	0,12	32.500	310	0,027	0,12	28.750	280	0,027	0,12
0,5	R0,05	1	40.000	880	0,03	0,24	40.000	790	0,024	0,24	40.000	880	0,03	0,24	40.000	880	0,03	0,24
0,5	R0,05	2	40.000	770	0,023	0,24	35.000	690	0,018	0,24	40.000	770	0,023	0,24	40.000	770	0,023	0,24
0,5	R0,05	3	35.000	650	0,019	0,24	30.000	510	0,015	0,24	40.000	740	0,019	0,24	40.000	740	0,019	0,24
0,5	R0,05	4	30.000	540	0,017	0,24	25.000	420	0,014	0,24	39.000	700	0,017	0,24	34.500	620	0,017	0,24
0,5	R0,05	5	25.000	370	0,016	0,24	20.000	300	0,013	0,24	32.500	480	0,016	0,24	28.750	430	0,016	0,24
0,5	R0,1	1	40.000	880	0,06	0,18	40.000	790	0,048	0,18	40.000	880	0,06	0,18	40.000	880	0,06	0,18
0,5	R0,1	2	40.000	770	0,045	0,18	35.000	690	0,036	0,18	40.000	770	0,045	0,18	40.000	770	0,045	0,18
0,5	R0,1	3	35.000	650	0,039	0,18	30.000	510	0,031	0,18	40.000	740	0,039	0,18	40.000	740	0,039	0,18
0,5	R0,1	4	30.000	540	0,034	0,18	25.000	420	0,027	0,18	39.000	700	0,034	0,18	34.500	620	0,034	0,18
0,5	R0,1	5	25.000	370	0,032	0,18	20.000	300	0,026	0,18	32.500	480	0,032	0,18	28.750	430	0,032	0,18
0,6	R0,05	1,2	40.000	1.120	0,03	0,3	35.000	880	0,024	0,3	40.000	1.120	0,03	0,3	40.000	1.120	0,03	0,3
0,6	R0,05	2	37.000	1.030	0,024	0,3	35.000	810	0,019	0,3	40.000	1.110	0,024	0,3	40.000	1.110	0,024	0,3
0,6	R0,05	4	29.000	710	0,019	0,3	26.000	580	0,015	0,3	37.700	920	0,019	0,3	33.350	820	0,019	0,3
0,6	R0,05	6	22.000	440	0,016	0,3	20.000	280	0,013	0,3	28.600	570	0,016	0,3	25.300	510	0,016	0,3
0,6	R0,1	1,2	40.000	1.120	0,06	0,24	35.000	880	0,048	0,24	40.000	1.120	0,06	0,24	40.000	1.120	0,06	0,24
0,6	R0,1	2	37.000	1.030	0,049	0,24	35.000	810	0,039	0,24	40.000	1.110	0,049	0,24	40.000	1.110	0,049	0,24
0,6	R0,1	3	33.000	800	0,042	0,24	30.000	660	0,034	0,24	40.000	970	0,042	0,24	37.950	920	0,042	0,24
0,6	R0,1	4	29.000	710	0,037	0,24	26.000	580	0,03	0,24	37.700	920	0,037	0,24	33.350	820	0,037	0,24
0,6	R0,1	6	22.000	440	0,032	0,24	20.000	280	0,026	0,24	28.600	570	0,032	0,24	25.300	510	0,032	0,24
0,6	R0,2	1,2	40.000	1.120	0,12	0,12	35.000	880	0,096	0,12	40.000	1.120	0,12	0,12	40.000	1.120	0,12	0,12
0,6	R0,2	4	29.000	710	0,074	0,12	26.000	580	0,059	0,12	37.700	920	0,074	0,12	33.350	820	0,074	0,12
0,8	R0,05	1,6	36.000	1.580	0,03	0,42	32.000	1.270	0,024	0,42	40.000	1.760	0,03	0,42	40.000	1.760	0,03	0,42
0,8	R0,05	4	30.000	1.390	0,021	0,42	27.000	1.010	0,017	0,42	39.000	1.810	0,021	0,42	34.500	1.600	0,021	0,42
0,8	R0,05	6	25.000	1.000	0,018	0,42	23.000	800	0,014	0,42	32.500	1.300	0,018	0,42	28.750	1.150	0,018	0,42
0,8	R0,05	8	20.000	750	0,016	0,42	18.000	620	0,013	0,42	26.000	980	0,016	0,42	23.000	860	0,016	0,42
0,8	R0,1	1,6	36.000	1.580	0,06	0,36	32.000	1.270	0,048	0,36	40.000	1.760	0,06	0,36	40.000	1.760	0,06	0,36
0,8	R0,1	4	30.000	1.240	0,042	0,36	27.000	1.010	0,034	0,36	39.000	1.610	0,042	0,36	34.500	1.430	0,042	0,36
0,8	R0,1	6	25.000	1.000	0,035	0,36	23.000	800	0,028	0,36	32.500	1.300	0,035	0,36	28.750	1.150	0,035	0,36
0,8	R0,1	8	20.000	750	0,032	0,36	18.000	620	0,026	0,36	26.000	980	0,032	0,36	23.000	860	0,032	0,36
1	R0,02	2	32.000	2.880	0,01	0,6	29.000	2.350	0,008	0,6	40.000	3.600	0,01	0,6	36.800	3.310	0,01	0,6
1	R0,02	3	30.000	2.690	0,009	0,6	27.000	2.180	0,007	0,6	39.000	3.500	0,009	0,6	34.500	3.090	0,009	0,6
1	R0,1	2	32.000	2.880	0,06	0,5	29.000	2.350	0,05	0,5	40.000	3.600	0,06	0,5	36.800	3.310	0,06	0,5
1	R0,1	3	30.000	2.690	0,053	0,5	27.000	2.180	0,042	0,5	39.000	3.500	0,053	0,5	34.500	3.090	0,053	0,5
1	R0,1	4	28.000	2.500	0,049	0,5	25.000	1.940	0,039	0,5	36.400	3.250	0,049	0,5	32.200	2.880	0,049	0,5
1	R0,1	5	27.000	2.240	0,046	0,5	24.000	1.800	0,037	0,5	35.100	2.910	0,046	0,5	31.050	2.580	0,046	0,5
1	R0,1	6	25.000	2.070	0,043	0,5	23.000	1.650	0,034	0,5	32.500	2.690	0,043	0,5	28.750	2.380	0,043	0,5
1	R0,1	8	21.000	1.740	0,04	0,5	19.000	1.440	0,032	0,5	27.300	2.260	0,04	0,5	24.150	2.000	0,04	0,5
1	R0,1	10	18.000	1.390	0,037	0,5	16.000	1.130	0,03	0,5	23.400	1.810	0,037	0,5	20.700	1.600	0,037	0,5
1	R0,2	2	32.000	2.880	0,12	0,4	29.000	2.350	0,1	0,4	40.000	3.600	0,12	0,4	36.800	3.310	0,12	0,4
1	R0,2	3	30.000	2.690	0,11	0,4	27.000	2.180	0,08	0,4	39.000	3.500	0,106	0,4	34.500	3.090	0,106	0,4
1	R0,2	4	28.000	2.500	0,1	0,4	25.000	1.940	0,08	0,4	36.400	3.250	0,097	0,4	32.200	2.880	0,097	0,4
1	R0,2	5	27.000	2.240	0,09	0,4	24.000	1.800	0,07	0,4	35.100	2.910	0,091	0,4	31.050	2.580	0,091	0,4
1	R0,2	6	25.000	2.070	0,09	0,4	23.000	1.650	0,07	0,4	32.500	2.690	0,086	0,4	28.750	2.380	0,086	0,4
1	R0,2	8	21.000	1.740	0,08	0,4	19.000	1.440	0,06	0,4	27.300	2.260	0,079	0,4	24.150	2.000	0,079	0,4
1	R0,2	10	18.000	1.390	0,07	0,4	16.000	1.130	0,06	0,4	23.400	1.810	0,074	0,4	20.700	1.600	0,074	0,4
1	R0,3	2	32.000	2.880	0,2	0,3	29.000	2.350</										

CUTTING CONDITIONS

Milling | Endmills | Cutting conditions

AE-CPR-N

Work Material			Copper C1020 - C1100				Copper Tungsten W70% - Cu30%				Wrought aluminium alloy A7075				Aluminium alloy casting • Die casting <SI 13%			
DC	RE	LU (mm)	S (min ⁻¹)	F (mm/min)	Depth of cut (mm)		S (min ⁻¹)	F (mm/min)	Depth of cut (mm)		S (min ⁻¹)	F (mm/min)	Depth of cut (mm)		S (min ⁻¹)	F (mm/min)	Depth of cut (mm)	
					ap	ae			ap	ae			ap	ae			ap	ae
2	R0,2	16	11.500	1.790	0,09	1	10.500	1.460	0,07	1	14.950	2330	0,085	1	13.225	2060	0,085	1
2	R0,2	20	9.500	1.460	0,08	1	8.500	1.190	0,06	1	12.350	1900	0,08	1	10.925	1680	0,08	1
2	R0,3	4	17.500	3.150	0,2	0,9	16.000	2.560	0,16	0,9	22.750	4100	0,2	0,9	20.125	3620	0,2	0,9
2	R0,3	6	16.500	2.930	0,18	0,9	15.000	2.370	0,14	0,9	21.450	3810	0,181	0,9	18.975	3370	0,181	0,9
2	R0,3	8	15.500	2.630	0,17	0,9	14.000	2.130	0,13	0,9	20.150	3420	0,168	0,9	17.825	3020	0,168	0,9
2	R0,3	10	14.500	2.420	0,16	0,9	13.000	1.970	0,13	0,9	18.850	3150	0,159	0,9	16.675	2780	0,159	0,9
2	R0,3	15	12.000	1.910	0,14	0,9	11.000	1.550	0,12	0,9	15.600	2480	0,144	0,9	13.800	2200	0,144	0,9
2	R0,3	16	11.500	1.790	0,14	0,9	10.500	1.460	0,11	0,9	14.950	2330	0,141	0,9	13.225	2060	0,141	0,9
2	R0,3	20	9.500	1.460	0,13	0,9	8.500	1.190	0,11	0,9	12.350	1900	0,134	0,9	10.925	1680	0,134	0,9
2,5	R0,5	5	15.000	3.600	0,3	0,9	13.500	2.920	0,24	0,9	19.500	4680	0,3	0,9	17.250	4140	0,3	0,9
2,5	R0,5	20	11.500	2.040	0,21	0,9	10.500	1.660	0,17	0,9	14.950	2650	0,212	0,9	13.225	2350	0,212	0,9
3	R0,2	6	12.500	3.750	0,12	1,6	11.500	3.050	0,1	1,6	16.250	4880	0,12	1,6	14.375	4310	0,12	1,6
3	R0,2	12	11.500	3.190	0,1	1,6	10.500	2.600	0,08	1,6	14.950	4150	0,104	1,6	13.225	3670	0,104	1,6
3	R0,2	18	10.500	2.680	0,1	1,6	9.500	2.180	0,08	1,6	13.650	3480	0,096	1,6	12.075	3080	0,096	1,6
3	R0,2	21	10.000	2.440	0,09	1,6	9.000	1.970	0,07	1,6	13.000	3170	0,093	1,6	11.500	2810	0,093	1,6
3	R0,2	24	9.500	2.210	0,09	1,6	8.500	1.800	0,07	1,6	12.350	2870	0,091	1,6	10.925	2540	0,091	1,6
3	R0,3	6	12.500	3.750	0,2	1,5	11.500	3.050	0,16	1,5	16.250	4880	0,2	1,5	14.375	4310	0,2	1,5
3	R0,3	8	12.000	3.510	0,19	1,5	11.000	2.840	0,15	1,5	15.600	4560	0,189	1,5	13.800	4040	0,189	1,5
3	R0,3	12	11.500	3.190	0,17	1,5	10.500	2.600	0,14	1,5	14.950	4150	0,174	1,5	13.225	3670	0,174	1,5
3	R0,3	20	10.500	2.600	0,16	1,5	9.500	2.120	0,13	1,5	13.650	3380	0,157	1,5	12.075	2990	0,157	1,5
3	R0,5	6	12.500	3.750	0,3	1,2	11.500	3.050	0,24	1,2	16.250	4880	0,3	1,2	14.375	4310	0,3	1,2
3	R0,5	12	11.500	3.190	0,26	1,2	10.500	2.600	0,21	1,2	14.950	4150	0,261	1,2	13.225	3670	0,261	1,2
3	R0,5	15	11.000	2.930	0,25	1,2	10.000	2.370	0,2	1,2	14.300	3810	0,25	1,2	12.650	3370	0,25	1,2
3	R0,5	18	10.500	2.680	0,24	1,2	9.500	2.180	0,19	1,2	13.650	3480	0,241	1,2	12.075	3080	0,241	1,2
3	R0,5	21	10.000	2.440	0,23	1,2	9.000	1.970	0,19	1,2	13.000	3170	0,234	1,2	11.500	2810	0,234	1,2
3	R0,5	25	9.500	2.170	0,23	1,2	8.500	1.770	0,18	1,2	12.350	2820	0,226	1,2	10.925	2500	0,226	1,2
3	R0,5	30	8.500	1.790	0,22	1,2	8.000	1.460	0,17	1,2	11.050	2330	0,217	1,2	9.775	2060	0,217	1,2
4	R0,2	8	9.500	3.710	0,12	2,2	8.600	3.020	0,1	2,2	12.350	4820	0,12	2,2	10.925	4270	0,12	2,2
4	R0,2	16	8.800	3.220	0,1	2,2	7.900	2.600	0,08	2,2	11.440	4190	0,104	2,2	10.120	3700	0,104	2,2
4	R0,2	20	8.500	3.000	0,1	2,2	7.700	2.450	0,08	2,2	11.050	3900	0,1	2,2	9.775	3450	0,1	2,2
4	R0,2	24	8.100	2.760	0,1	2,2	7.300	2.240	0,08	2,2	10.530	3590	0,096	2,2	9.315	3170	0,096	2,2
4	R0,2	28	7.700	2.530	0,09	2,2	6.900	2.040	0,07	2,2	10.010	3290	0,093	2,2	8.855	2910	0,093	2,2
4	R0,2	32	7.400	2.350	0,09	2,2	6.700	1.910	0,07	2,2	9.620	3060	0,091	2,2	8.510	2700	0,091	2,2
4	R0,3	8	9.500	3.710	0,2	2,1	8.600	3.020	0,16	2,1	12.350	4820	0,2	2,1	10.925	4270	0,2	2,1
4	R0,3	20	8.400	2.970	0,17	2,1	7.600	2.420	0,13	2,1	10.920	3860	0,167	2,1	9.660	3420	0,167	2,1
4	R0,5	8	9.500	3.710	0,3	1,8	8.600	3.020	0,24	1,8	12.350	4820	0,3	1,8	10.925	4270	0,3	1,8
4	R0,5	12	9.100	3.440	0,28	1,8	8.200	2.790	0,22	1,8	11.830	4470	0,277	1,8	10.465	3960	0,277	1,8
4	R0,5	16	8.800	3.220	0,26	1,8	7.900	2.600	0,21	1,8	11.440	4190	0,261	1,8	10.120	3700	0,261	1,8
4	R0,5	20	8.400	2.970	0,25	1,8	7.600	2.420	0,2	1,8	10.920	3860	0,25	1,8	9.660	3420	0,25	1,8
4	R0,5	24	8.100	2.760	0,24	1,8	7.300	2.240	0,19	1,8	10.530	3590	0,241	1,8	9.315	3170	0,241	1,8
4	R0,5	25	8.000	2.710	0,24	1,8	7.200	2.190	0,19	1,8	10.400	3520	0,239	1,8	9.200	3120	0,239	1,8
4	R0,5	28	7.700	2.530	0,23	1,8	6.900	2.040	0,19	1,8	10.010	3290	0,234	1,8	8.855	2910	0,234	1,8
4	R0,5	32	7.400	2.350	0,23	1,8	6.700	1.910	0,18	1,8	9.620	3060	0,227	1,8	8.510	2700	0,227	1,8
4	R1	8	9.500	3.710	0,6	1,2	8.600	3.020	0,48	1,2	12.350	4820	0,6	1,2	10.925	4270	0,6	1,2
4	R1	16	8.800	3.220	0,52	1,2	7.900	2.600	0,42	1,2	11.440	4190	0,522	1,2	10.120	3700	0,522	1,2
4	R1	24	8.100	2.760	0,48	1,2	7.300	2.240	0,39	1,2	10.530	3590	0,482	1,2	9.315	3170	0,482	1,2
4	R1	28	7.700	2.530	0,47	1,2	6.900	2.040	0,37	1,2	10.010	3290	0,467	1,2	8.855	2910	0,467	1,2
4	R1	32	7.400	2.350	0,46	1,2	6.700	1.910	0,36	1,2	9.620	3060	0,455	1,2	8.510	2700	0,455	1,2
6	R0,1	12	6.500	3.900	0,06	3,5	5.900	3.190	0,05	3,5	8.450	5070	0,06	3,5	7.475	4490	0,06	3,5
6	R0,1	24	6.000	3.380	0,05	3,5	5.400	2.730	0,04	3,5	7.800	4390	0,052	3,5	6.900	3890	0,052	3,5
6	R0,2	12	6.500	3.900	0,12	3,4	5.900	3.190	0,1	3,4	8.450	5070	0,12	3,4	7.475	4490	0,12	3,4
6	R0,2	24	6.000	3.380	0,1	3,4	5.400	2.730	0,08	3,4	7.800	4390	0,104	3,4	6.900	3890	0,104	3,4
6	R0,2	32	5.700	3.060	0,1	3,4	5.100	2.470	0,08	3,4	7.410	3980	0,099	3,4	6.555	3520	0,099	3,4
6	R0,2	48	5.000	2.440	0,09	3,4	4.500	1.980	0,07	3,4	6.500	3170	0,091	3,4	5.750	2810	0,091	3,4
6	R0,5	12	6.500	3.900	0,3	3	5.900	3.190	0,24	3	8.450	5070	0,3	3	7.475	4490	0,3	3
6	R0,5	24	6.000	3.380	0,26	3	5.400	2.730	0,21	3	7.800	4390	0,261	3	6.900	3890	0,261	3
6	R0,5	30	5.800	3.150	0,25	3	5.200	2.550	0,2	3	7.540	4100	0,25	3	6.670	3620	0,25	3
6	R0,5	32	5.700	3.060	0,25	3	5.100	2.470	0,2	3	7.410	3980	0,247	3	6.555	3520	0,247	3
6	R0,5	48	5.000	2.440	0,23	3	4.500	1.980	0,18	3	6.500	3170	0,227	3	5.750	2810	0,227	3
6	R1	12	6.500	3.900	0,6	2,4	5.900	3.190	0,48	2,4	8.450	5070	0,6	2,4	7.475	4490	0,6	2,4
6	R1	24	6.000	3.380	0,52	2,4	5.400	2.730	0,42	2,4	7.800	4390	0,522	2,4	6.900	3890	0,522	2,4
6	R1	32	5.700	3.060	0,49	2,4	5.100	2.470	0,39	2,4	7.410	3980	0,493	2,4	6.555	3520	0,493	2,4
6	R1	48	5.000	2.440	0,46	2,4	4.500	1.980	0,36	2,4	6.500	3170	0,455	2,4	5.750	2810	0,455	2,4

Depth of cut

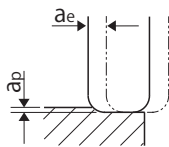

1. Use a rigid and precise machine and holder.
2. Please adjust the speed and feed when the cutting depth is large or when machines with low rigidity are used.
3. Use a water soluble fluid.
4. Use a non-water-soluble cutting fluid if the machined surface and accuracy are of critical importance.
Adjust the depth of cut and feed rate as necessary.
5. Always use a cutting fluid recommended by the cutting fluid manufacturer as the workpiece may discolor.



KEY FEATURES: PXAL



1 Suitable for large-diameter milling with high surface quality

2 Exchangeable Head End Mill PXM for Non-Ferrous Materials

3 DLC-IGUSS Coating



Due to the smoothness of the coating surface, it is extremely effective for non-ferrous materials such as aluminum alloys that require welding resistance and lubricity. Moreover, tool durability is also improved.

SUITABLE FOR LARGE-DIAMETER MILLING WITH HIGH SURFACE QUALITY

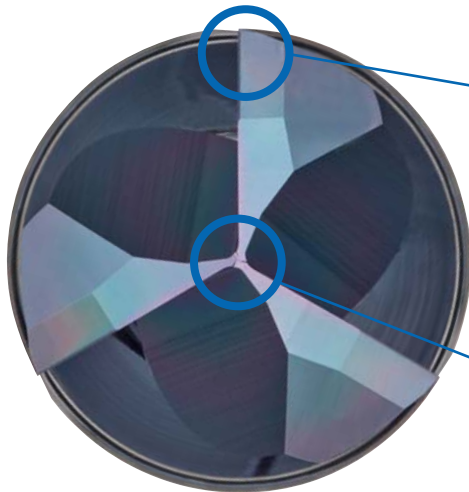

Flat cutting edge

Achieves higher precision machined surface quality

Large core design

High rigidity prevents chattering

Center cutting edge

Can be used for plunging

Utilizes XP4625 grade suitable for non-ferrous metal applications

By adopting a grade optimal for non-ferrous materials such as aluminum alloy, excellent wear resistance, welding resistance, and long tool life can be achieved.

Abundant lineup in various shapes and styles

An abundant lineup including square type, radius type, and reduced shank type are available to accommodate a wide range of applications.

Tightening procedure

1. Cleaning
Remove dirt and chips from the connecting thread and shank.

2. Initial Tightening
Tighten by hand

3. Final Tightening
Tighten with a spanner wrench

4. Confirmation
Confirm that there is no gap

Cautions during use

- Only use the spanner wrenches that are designed specifically for the PXM (P. 13). Please do not use alternative spanner wrenches sold on the market as a replacement.
- Please tighten until the head and the shank holder faces meet. Confirm that there is no gap.
- Degreasing the connecting thread may result in over tightening or a possible separation of the faces. Please do not degrease.
- Please make sure that the spanner wrench is inserted properly and turn it slowly during use.



CUTTING DATA

Improved surface roughness by the effect of the flat cutting edge specification

Tool	Head: PXAL160C16-03R000 Holder: PXMZ-C16SS16-S100	Non-coated Competitor A, B, C
Size	Ø16	Ø16 3 flutes
Work Material	A7075	
Milling Method	Side Milling	
Cutting Speed	600m/min (12.000min ⁻¹)	
Feed	5.400mm/min(0.15mm/t)	
Depth of Cut	ap =8mm (0,5D) ae=4,8mm (0,3D)	
Overhang Length	50mm (L/D= 3,1)	
Coolant	Water Soluble	
Machine	Vertical Machining Center (BT40)	

Bottom surface roughness after milling 465 m

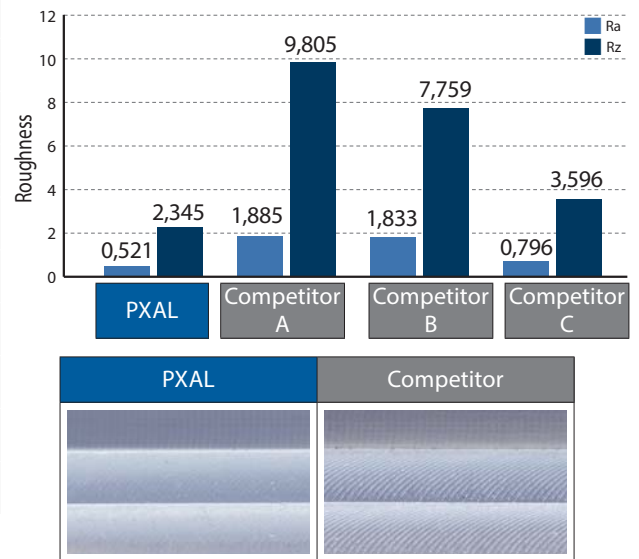

Achieves good surface finish regardless of coolant type

Tool	Head: PXAL160C16-03R000 Holder: PXMZ-C16SS16-S100	Non-coated Competitor
Size	Ø16	Ø16 3 flutes
Work Material	A7075	
Milling Method	Side Milling	
Cutting Speed	600m/min (12.000min ⁻¹)	
Feed	2.700mm/min(0.075mm/t)	
Depth of Cut	ap =8mm (0,5D) ae=4,8mm (0,3D)	
Overhang Length	50mm (L/D= 3,1)	
Machine	Vertical Machining Center (BT40)	

Surface roughness after milling 462 m

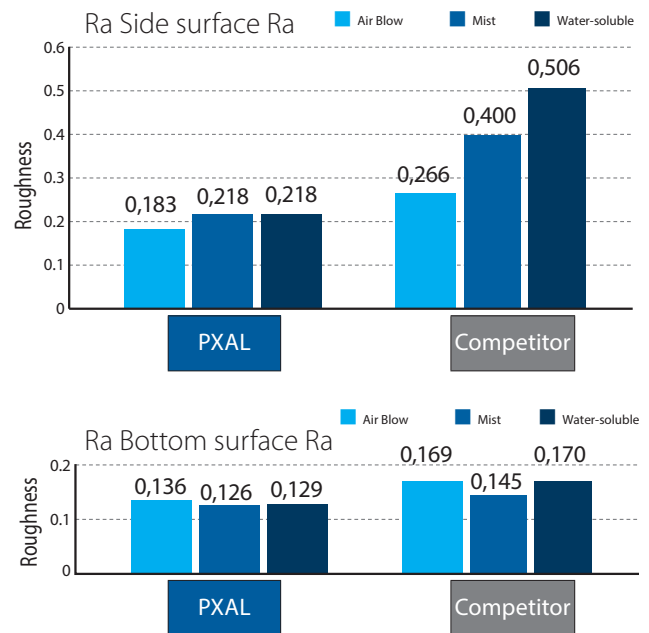

Welding suppression by DLC coating

Tool	Head: PXAL160C16-03R010 Holder: PXMZ-C16SS16-S100	Non-coated Competitor
Size	Ø16 x R1	Ø16 x R1 3 flutes
Work Material	A7075	
Cutting Speed	600m/min (12.000min ⁻¹)	
Feed	2.700mm/min(0.075mm/t)	
Milling Method	Side Milling	
Depth of Cut	ap =8mm (0,5D) ae=4,8mm (0,3D)	
Overhang Length	50mm	
Coolant	None Air Blow	
Machine	Vertical Machining Center (BT40)	

Cutting edge condition after milling 300 m



PXAL HEADS

Milling | Indexable | Heads

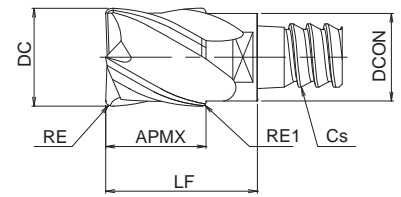

- 3 flutes solid carbide head
- For Non-ferrous materials
- For PXMZ straight shank holder
- 10 - 25 mm



EDP	Designation	ZEFP	DC	RE	APMX	LF	DCON	CS	FHA	Grade	P		M		K		N		S		H		
											dry	oil	dry	oil	GG	GGG	dry	oil	dry	oil	dry	oil	
7834930	PXAL100C10-03R000	3	10	-	10	16	9,8	C10	45	XP4625								●	●				
7834931	PXAL100C10-03R100	3	10	1	10	16	9,8	C10	45	XP4625								●	●				
7834932	PXAL100C10-03R250	3	10	2,5	10	16	9,8	C10	45	XP4625								●	●				
7834933	PXAL120C10-03R000	3	12	-	12	18	9,8	C10	45	XP4625								●	●				
7834934	PXAL120C12-03R000	3	12	-	12	18	11,7	C12	45	XP4625								●	●				
7834935	PXAL120C12-03R100	3	12	1	12	18	11,7	C12	45	XP4625								●	●				
7834936	PXAL120C12-03R300	3	12	3	12	18	11,7	C12	45	XP4625								●	●				
7834937	PXAL140C12-03R000	3	14	-	14	20	11,7	C12	45	XP4625								●	●				
7834938	PXAL160C16-03R000	3	16	-	16	23,5	15,7	C16	45	XP4625								●	●				
7834939	PXAL160C16-03R100	3	16	1	16	23,5	15,7	C16	45	XP4625								●	●				
7834940	PXAL160C16-03R200	3	16	2	16	23,5	15,7	C16	45	XP4625								●	●				
7834941	PXAL160C16-03R300	3	16	3	16	23,5	15,7	C16	45	XP4625								●	●				
7834942	PXAL160C16-03R400	3	16	4	16	23,5	15,7	C16	45	XP4625								●	●				
7834943	PXAL180C16-03R000	3	18	-	18	25,5	15,7	C16	45	XP4625								●	●				
7834944	PXAL200C20-03R000	3	20	-	20	27,5	19,6	C20	45	XP4625								●	●				
7834945	PXAL200C20-03R100	3	20	1	20	27,5	19,6	C20	45	XP4625								●	●				
7834946	PXAL200C20-03R200	3	20	2	20	27,5	19,6	C20	45	XP4625								●	●				
7834947	PXAL200C20-03R300	3	20	3	20	27,5	19,6	C20	45	XP4625								●	●				
7834948	PXAL200C20-03R400	3	20	4	20	27,5	19,6	C20	45	XP4625								●	●				
7834949	PXAL220C20-03R000	3	22	-	22	29,5	19,6	C20	45	XP4625								●	●				
7834950	PXAL250C25-03R000	3	25	-	25	35	24	C25	45	XP4625								●	●				
7834951	PXAL250C25-03R100	3	25	1	25	35	24	C25	45	XP4625								●	●				
7834952	PXAL250C25-03R300	3	25	3	25	35	24	C25	45	XP4625								●	●				
7834953	PXAL250C25-03R500	3	25	5	25	35	24	C25	45	XP4625								●	●				

Milling | Indexable
Heads



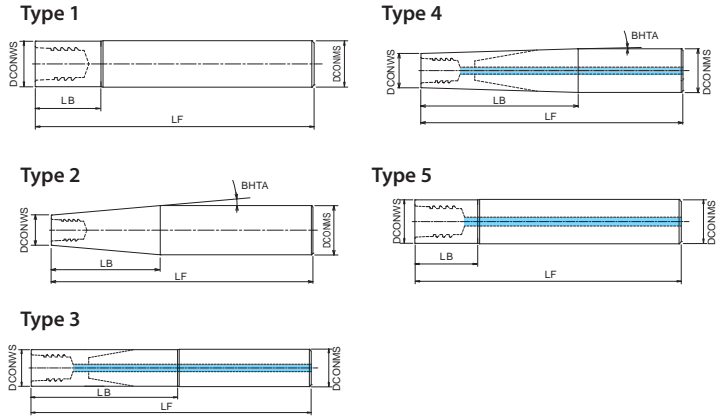

- Exchangeable carbide/steel body for PXM

EDP	Designation	CS	LF	DCONWS	LB	DCON	BHTA	Type	Shank material
48174001	PXMZ-C12SS12-S100	C12	100	11,7	18	12	0	1	Steel
48174002	PXMZ-C12TP20-S145	C12	145	11,7	47,4	20	5	2	Steel
48174003	PXMZ-C16SS16-S100	C16	100	15,7	23	16	0	1	Steel
48174004	PXMZ-C16TP25-S155	C16	155	15,7	53,1	25	5	2	Steel
48174005	PXMZ-C20SS20-S120	C20	120	19,6	28	20	0	1	Steel
48174006	PXMZ-C20TP32-S170	C20	170	19,6	70,8	32	5	2	Steel
48174007	PXMZ-C25SS25-S140	C25	140	24	34,5	25	0	1	Steel
48174022	PXMZ-C32SS32-S160	C32	160	28	33	32	0	1	Steel
48309001	PXMZ-C12SS12-S100-O	C12	100	11,7	18	12	0	5	Steel
48309002	PXMZ-C16SS16-S100-O	C16	100	15,7	23	16	0	5	Steel
48309003	PXMZ-C20SS20-S120-O	C20	120	19,6	28	20	0	5	Steel
48309004	PXMZ-C25SS25-S140-O	C25	140	24	34,5	25	0	5	Steel
48174008	PXMZ-C12SS12-S075CS	C12	75	11,7	24	12	0	1	Carbide
48174009	PXMZ-C12SS12-L100CS	C12	100	11,7	45,9	12	0	1	Carbide
48174010	PXMZ-C12SS12-L115CS	C12	115	11,7	64,2	12	0	1	Carbide
48174011	PXMZ-C12TP16-LL135CS	C12	135	11,7	83,8	16	1,3	2	Carbide
48174012	PXMZ-C16SS16-S090CS	C16	90	15,7	39,2	16	0	1	Carbide
48174013	PXMZ-C16SS16-L130CS	C16	130	15,7	61,2	16	0	1	Carbide
48174014	PXMZ-C16SS16-L135CS	C16	135	15,7	84,2	16	0	1	Carbide
48174015	PXMZ-C16TP20-LL165CS	C16	165	15,7	115	20	1,1	2	Carbide
48174016	PXMZ-C20SS20-S090CS	C20	90	19,6	39,1	20	0	1	Carbide
48174017	PXMZ-C20SS20-L150CS	C20	150	19,6	78,4	20	0	1	Carbide
48174018	PXMZ-C20SS20-L180CS	C20	180	19,6	109,1	20	0	1	Carbide
48174019	PXMZ-C20TP25-LL200CS	C20	200	19,6	140	25	1,1	2	Carbide
48174020	PXMZ-C25SS25-L200CS	C25	200	24	96,6	25	0	1	Carbide
48174021	PXMZ-C10SS10-S075	C10	75	9,8	12	10	0	1	Carbide
48174023	PXMZ-C10SS10-L100CS	C10	100	9,8	37,3	10	0	1	Carbide
48174024	PXMZ-C32SS32-L250CS	C32	250	28	115,2	32	0	1	Carbide
48174025	PXMZ-C10SS10-S075CS	C10	75	9,8	17,3	10	0	1	Carbide
48174026	PXMZ-C10TP12-LL130CS	C10	130	9,8	67	12	0,9	2	Carbide
48309005	PXMZ-C12SS12-S075CS-O	C12	75	11,7	25	12	0	3	Carbide
48309006	PXMZ-C12SS12-L100CS-O	C12	100	11,7	46,3	12	0	3	Carbide
48309007	PXMZ-C12SS12-L115CS-O	C12	115	11,7	65	12	0	3	Carbide
48309008	PXMZ-C12TP16-LL135CS-O	C12	135	11,7	85	16	1,3	4	Carbide
48309009	PXMZ-C12TP16-LL150CS-O	C12	150	11,7	85,6	16	1	4	Carbide
48309010	PXMZ-C16SS16-S090CS-O	C16	90	15,7	40	16	0	3	Carbide
48309011	PXMZ-C16SS16-L130CS-O	C16	130	15,7	62	16	0	3	Carbide
48309012	PXMZ-C16SS16-L135CS-O	C16	135	15,7	85	16	0	3	Carbide
48309013	PXMZ-C16TP20-LL165CS-O	C16	165	15,7	115	20	1	4	Carbide
48309014	PXMZ-C16TP20-LL180CS-O	C16	180	15,7	116,6	20	1	4	Carbide
48309015	PXMZ-C20SS20-S090CS-O	C20	90	19,6	40	20	0	3	Carbide
48309016	PXMZ-C20SS20-L150CS-O	C20	150	19,6	79,3	20	0	3	Carbide
48309017	PXMZ-C20SS20-L180CS-O	C20	180	19,6	110	20	0	3	Carbide
48309018	PXMZ-C20TP25-LL200CS-O	C20	200	19,6	140	25	1	4	Carbide
48309019	PXMZ-C20TP25-LL210CS-O	C20	210	19,6	145	25	1	4	Carbide
48309020	PXMZ-C25SS25-L200CS-O	C25	200	24	98	25	0	3	Carbide

Accessories and spare parts

Applicable head	EDP	Designation	Torque	Specification
10-12	7801890	PXMP8-10	10 N.m	Spanner
12-14	7801890	PXMP8-10	12 N.m	Spanner
16-18	7801891	PXMP13-16	30 N.m	Spanner
20-22	7801891	PXMP13-16	50 N.m	Spanner
25	7801892	PXMP21	60 N.m	Spanner
32	7801897	PXMP24	60 N.m	Spanner

CUTTING CONDITIONS

Milling | Indexables | Cutting conditions

PXAL

Side milling $L/D \leq 3$

Aluminum Alloy Expanding Material A5052 • A7075			
\emptyset	S (min^{-1})	F (mm/min)	
10	16.000	4.800	
12	13.300	3.990	
14	11.400	3.420	
16	10.000	3.600	
18	8.900	3.210	
20	8.000	3.840	
22	7.300	3.510	
25	6.400	3.840	
Depth of cut	ap		ae
	0,7 D		0,2 D

PXAL

Side milling $3 < L/D \leq 5$

Aluminum Alloy Expanding Material A5052 • A7075			
\emptyset	S (min^{-1})	F (mm/min)	
10	9.600	2.310	
12	8.000	1.920	
14	6.900	1.660	
16	6.000	1.730	
18	5.400	1.560	
20	4.800	1.850	
22	4.400	1.690	
25	3.900	1.880	
Depth of cut	ap		ae
	0,7 D		0,08 D

PXAL

Side milling $5 < L/D \leq 7$

Aluminum Alloy Expanding Material A5052 • A7075			
\emptyset	S (min^{-1})	F (mm/min)	
10	6.400	1.390	
12	5.400	1.170	
14	4.600	1.000	
16	4.000	1.040	
18	3.600	940	
20	3.200	1.110	
22	2.900	1.010	
25	2.600	1.130	
Depth of cut	ap		ae
	0,7 D		0,04 D

CUTTING CONDITIONS

Milling | Indexables | Cutting conditions

PXAL

Slot milling L/D ≤ 3

Aluminum Alloy Expanding Material A5052 • A7075		
Ø	S (min ⁻¹)	F (mm/min)
10	16.000	4.800
12	13.300	3.990
14	11.400	3.420
16	10.000	3.000
18	8.900	2.670
20	8.000	2.400
22	7.300	2.190
25	6.400	1.920

Depth of cut	ap
	0,5 D

PXAL

Slot milling 3 < L/D ≤ 5

Aluminum Alloy Expanding Material A5052 • A7075		
Ø	S (min ⁻¹)	F (mm/min)
10	9.600	2.160
12	8.000	1.800
14	6.900	1.560
16	6.000	1.350
18	5.400	1.220
20	4.800	1.080
22	4.400	990
25	3.900	880

Depth of cut	ap
	0,35 D

PXAL

Slot milling 5 < L/D ≤ 7

Aluminum Alloy Expanding Material A5052 • A7075		
Ø	S (min ⁻¹)	F (mm/min)
10	6.400	960
12	5.400	810
14	4.600	690
16	4.000	600
18	3.600	540
20	3.200	480
22	2.900	440
25	2.600	390

Depth of cut	ap
	0,2 D

1. Use a rigid and precise machine and holder.
2. Please adjust the speed and feed when the depth of cut is large or when machines with low rigidity are used.
3. Please adjust the cutting condition when the overhang length is longer.
4. Please consider the overhang length as the total length of replaceable head and overhang length of shank holder.
5. When milling copper and copper alloys, lower the rotational speed by 20 to 40%, feed rate by 50 to 80%, and cutting depth by ap 50 to 80% in accordance with the table above.
6. Please always use the appropriate cutting fluid recommended by the cutting fluid manufacturer in the machining of magnesium alloys. Be cautious with the cutting chips as they are highly flammable and may pose a serious fire risk if not properly handled.



KEY FEATURES: PXMC COLLET

- 1** Powerful chip evacuation even on small machining center
- 2** The reduction of overhang length improves rigidity and rotational balance
- 3** A wide variety of exchangeable heads
 - Suitable for steel, stainless steel and aluminum
 - Wide processing range from roughing to finishing
- 4** Greater cost performance compared to monoblock type holders, only need to change the collet in case of trouble.

PXMC Collet Extra Short Type Conventional Combination

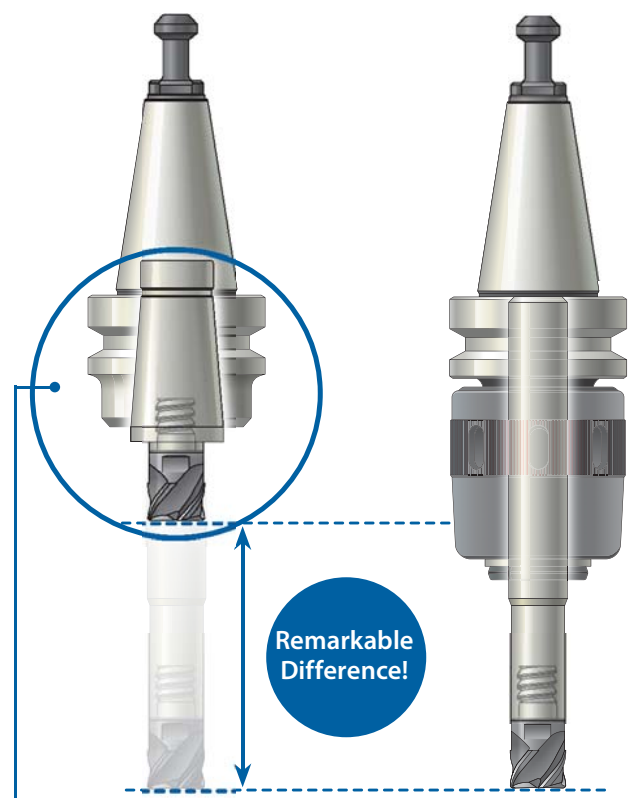

KEY FEATURES: PXM EXCHANGEABLE HEAD

All the knowledge and know-how acquired by designing solid carbide end mills are found in these exchangeable heads.
 · Various types are available to meet variety of machining methods.

End Face + Taper = Double Face Clamping
 · High rigidity and accuracy of tightening
 · High precision of run out $\leq 0,015\text{mm}$
 · High head replacing accuracy = $\pm 0.03\text{mm}$

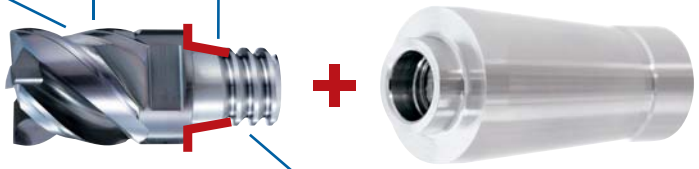

Applying buttress screw makes easy and reduces time to desorb heads

Milling | Indexables

CUTTING CONDITIONS

Milling | Indexables | Cutting conditions

PXAL + PXMC

Side milling Extra Short Type

Aluminum Alloy Expanding Material A5052 • A7075			
Ø	S (min ⁻¹)	F (mm/min)	
12	10.000	3.000	
14	10.000	3.000	
16	10.000	3.000	
18	8.900	3.210	
20	8.000	2.880	
22	7.300	3.510	
25	6.400	3.080	
Depth of cut	ap		ae
	0,7 D		0,2 D

Slot milling Extra Short Type

Aluminum Alloy Expanding Material A5052 • A7075			
Ø	S (min ⁻¹)	F (mm/min)	
12	10.000	3.000	
14	10.000	3.000	
16	10.000	3.000	
18	8.900	2.670	
20	8.000	2.400	
22	7.300	2.190	
25	6.400	1.920	
Depth of cut	ap		
	0,5 D		

Side milling Short Type

Aluminum Alloy Expanding Material A5052 • A7075			
Ø	S (min ⁻¹)	F (mm/min)	
12	10.000	2.700	
14	10.000	2.700	
16	10.000	2.700	
18	8.900	2.890	
20	8.000	2.600	
22	7.300	3.160	
25	6.400	2.770	
Depth of cut	ap		ae
	0,7 D		0,2 D

Slot milling Short Type

Aluminum Alloy Expanding Material A5052 • A7075			
Ø	S (min ⁻¹)	F (mm/min)	
12	10.000	2.700	
14	10.000	2.700	
16	10.000	2.700	
18	8.900	2.410	
20	8.000	2.160	
22	7.300	1.980	
25	6.400	1.730	
Depth of cut	ap		
	0,5 D		

1. Please adjust speed and feed when the depth of cut is large or machines with low rigidity are used.
2. When milling copper and copper alloys, lower the rotational speed by 20 to 40%, feed rate by 50 to 80%, and cutting depth by ap 50 to 80% in accordance with the table above.
3. Please always use the appropriate cutting fluid recommended by the cutting fluid manufacturer in the machining of magnesium alloys. Be cautious with the cutting chips as they are highly flammable and may pose a serious fire risk if not properly handled.

Milling | Indexable

Collets

MOUNTING PROCEDURE



1. Initial Tightening (BT30)

Make sure the fastening portion of the collet is clean then insert it into the holder. Turn the pull stud to tighten.

*For models other than BT30 please refer to the instructions below.



2. Final Tightening

Tighten with a spanner wrench



3. Cleaning

Remove dirt and chips from the connecting thread and collet



4. Mounting the Head

After screwing the head in by hand, use the PXM spanner wrench to tighten.

Mounting procedure for holders other than BT30

①

Insert the hexagon socket wrench into the pull screw hexagonal section.
*For pull studs with holes ($\phi 6$ or above), it is operational with the stud being attached.

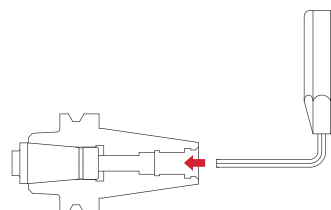

②

To prevent the collet from rotating, support the tip of the collet by hand, tighten with the wrench by turning to the right, then fastening to the required torque.
*Recommended tightening torque: 18N·m

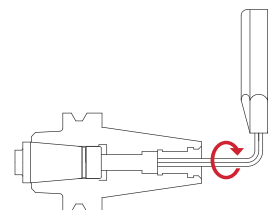

Cautions during use

- Only use the spanner wrenches that are designed specifically for the PXM (p.24) for attaching PXM heads .
- Please do not use alternative spanner wrenches sold on the market as a replacement.
- Please refer to p.24 for tightening torque.
- Please tighten until the head and the collet faces meet. Confirm that there is no gap.
- Degreasing the connecting thread may result in over tightening or a possible separation of the faces. Please do not degrease.
- Please make sure that the spanner wrench is inserted properly and turn it slowly during use.

Abundant exchangeable milling heads! Exchangeable head end mill PXM

The PXM is an exchangeable head end mill series with the same high performance of a solid tool and the cost efficiency of an indexable tool. A single exchangeable head body is able to accommodate a wide range of exchangeable heads to meet various application needs.

Available shapes

- Square Type
- Roughing Type
- Corner Radius Type
- Ball Type

Please see OSG PHOENIX Catalog for details.





shaping your dreams

OSG EUROPE LOGISTICS

Avenue Lavoisier 1
B-1300 Z.I. Wavre - Nord - Belgium
Tel: +32 10 23 05 07
Fax: +32 10 23 05 51
info@osgeurope.com

OSG BELUX

Avenue Lavoisier 1
B-1300 Z.I. Wavre - Nord - Belgium
Tel: +32 10 23 05 11
Fax: +32 10 23 05 31
info@osg-belgium.com

OSG FRANCE

Parc Icade, Paris Nord 2
Immeuble "Le Rimbaud"
22 Avenue des Nations
CS66191 - 93420 Villepinte - France
Tel: +33 1 49 90 10 10
Fax: +33 1 49 90 10 15
sales@osg-france.com

OSG NETHERLANDS

Bedrijfsweg 5 - 3481 MG Harmelen
Tel: +31 348 44 2764
Fax: +31 348 44 2144
info@osg-nl.com

OSG UK

Kelsey Close, Attleborough Fields Ind Est,
CV11 6RS, Nuneaton, United Kingdom.
Tel: +44 1827 720 013
uk_sales@osg-uk.com

CZECH, SLOVAKIA, HUNGARY

OSG Europe Logistics S.A.
Slovakia organizacna zlozka
Racianská 22/A, SK-83102 Bratislava
Slovakia
Tel. +421 24 32 91 295
Orders-osgsvk@osgeurope.com

OSG POLAND Sp. z o.o.

Spółdzielcza 57
05-074 Halinów - Poland
Tel: +22 760 82 71
Fax: +22 760 82 71
osg@osg-poland.com

OSG GERMANY

Karl-Ehmann-Str. 25
D - 73037 Göppingen - Germany
Tel: +49 7161 6064 - 0
Fax: +49 7161 6064 - 444
info@osg-germany.de

OSG SCANDINAVIA

(For Scandinavian countries)
Langebjergvaenget 16
4000 Roskilde - Denmark
Tel: +45 46 75 65 55
Fax: +45 46 75 67 00
osg@osg-scandinavia.com

SWEDEN

Branch office of OSG SCANDINAVIA
Singelgatan 7
212 28 Malmö - Sweden
Tel: +46 40 41 22 55
osg@osg-scandinavia.com

OSG IBERICA

Bekolarra 4
E - 01010 Vitoria-Gasteiz - Spain
Tel: +34 945 242 400
Fax: +34 945 228 883
osg.iberica@osg-ib.com

RUSSIA

Butlerova street, 17B, office 5069
117342 Moscow - Russia
Tel: +7 (495) 150 41 54
info@osg-russia.com

OSG TURKEY

Rami Kişla Cad.No:56 Eyüp
Istanbul 34056 - Turkey
Tel+90 212 565 24 00
Fax: +90 212 565 44 00
info@osg-turkey.com

ROMSAN INTERNATIONAL CO. SRL

Reprezentant Exclusiv OSG
25C, Bucuresti-Magurele Street
051431 Bucuresti - România
Tel: +40 21 322 07 47
Fax: +40 21 321 56 00
romsan.int@romsan.ro

AUSTRIA

Branch office of OSG GERMANY
Messestraße 11
A-6850 Dornbirn
Tel: +49 7161 6064-0
Fax: +49 7161 6064-444
info@osg-germany.de

OSG ITALIA

Via Ferrero, 65 A/B3
I - 10098 Rivoli - Italy
Tel: +39 0117705211
Fax: +39 0117705215
info@osg-italia.it

Vischer & Bolli AG

Machining and Workholding
Im Schossacher 17
CH-8600 Dübendorf
T +41 44 802 15 15
F +41 44 802 15 95
info@vb-tools.com

OSG EUROPE LOGISTICS S.A.

09/2023 - All rights reserved. © OSG Europe 2023.

The contents of this catalogue are provided to you for viewing only. They are not intended for reproduction either in part or in whole in this or other medium. They cannot be copied, used to create derivation work or used for any reason, by means without the express, written permission of the copyright owner. If prices are stated, they are netto unit-prices and any eventual taxes have to be added. The company is not responsible for any printing error in technical, price and/or any other data.

Tool specifications subject to change without notice.

www.osgeurope.com