

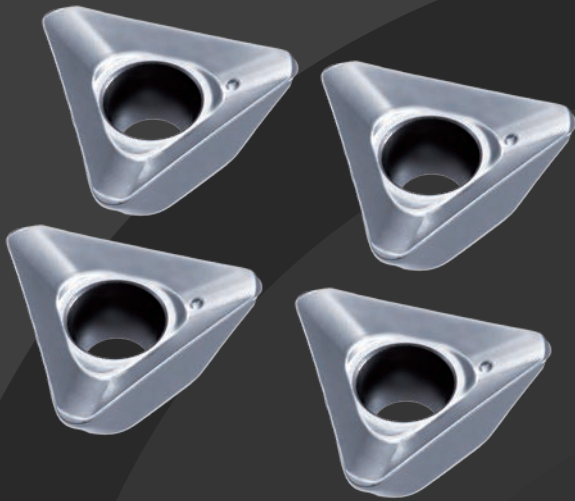

Centering and Chamfering Cutter

PLDS

Volume 1



KEY FEATURES: PLDS

Centering, countersinking and V slotting can be performed with a single tool

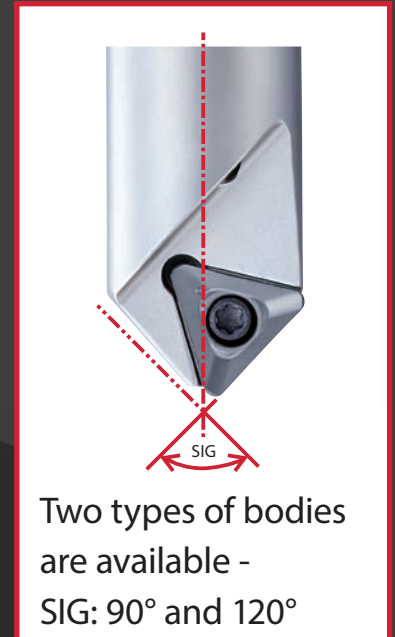
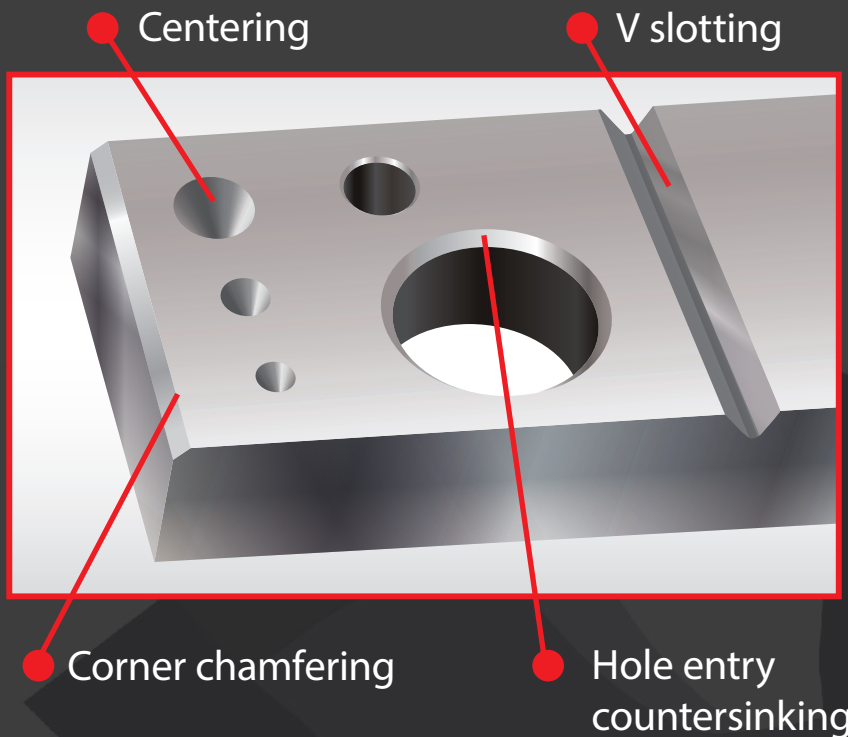

Economical 3-corner insert with both chipping resistance and sharpness

High-strength insert grades that can be selected according to the work material

For Steel and cast Iron

XP9020

For Stainless Steel
and heat resistant
alloys

XP2040

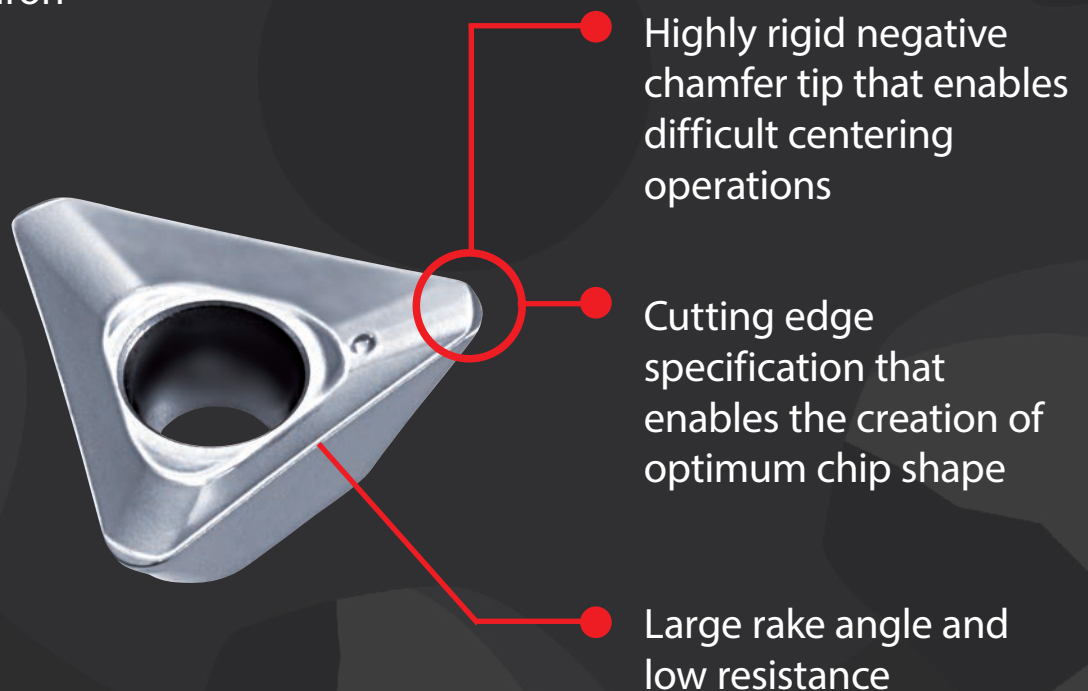

PHOENIX CENTERING AND CHAMFERING CUTTER

Optimal body design that enables long tool life and excellent machining surface

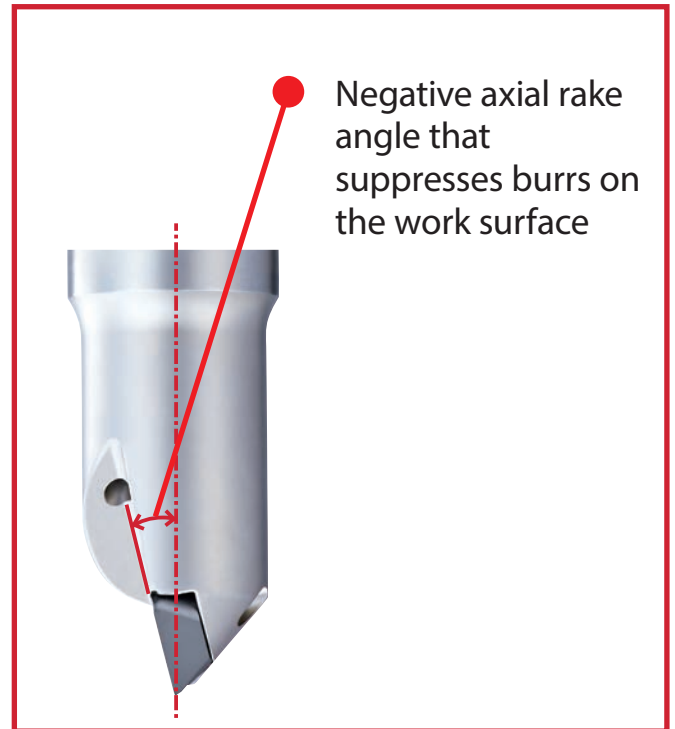
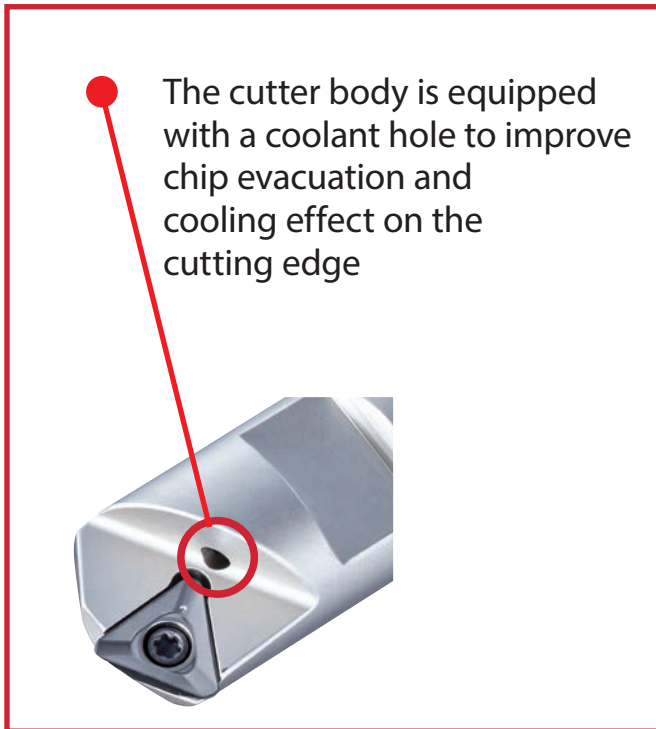

Machine Tips

Countersinking takes place after drilling!

For centering, make the centering diameter smaller than the drill diameter

Centering Drilling Countersinking

Inappropriate centering diameter relative to the drill diameter

Bottom tip shape

Center remnants

Center remnants may occur at the bottom of the hole due to the shape of the insert, which may adversely affect the drilling process.

Centering that also serves as countersinking

When the centering diameter becomes larger than the drill diameter, the shoulder of the drill will collide with the workpiece, which may cause chipping on the cutting edge.

PLDS SS

Centering and Chamfering | Indexables

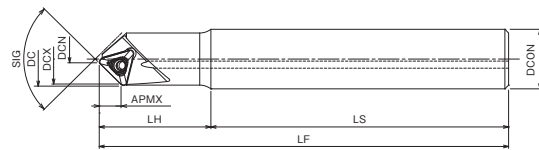

with Coolant Hole

- Centering and Chamfering Cutter
- Straight Shank Type
- With coolant hole
- 14,4 - 17,3 mm

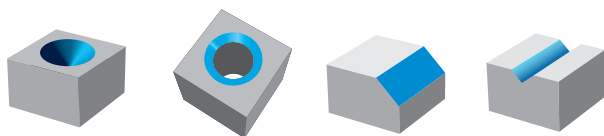



EDP	Designation	SIG	DCN	DCX	DC	ZEFP	DCON	Ls	OAL	LH	APMX	Price
7803401	PLDS11R002SS16-90	90°	2,5	13,5	14,4	1	16	80	110	30	5,8	
7803402	PLDS11R002SS16-L90	90°	2,5	13,5	14,4	1	16	170	200	30	5,8	
7803403	PLDS11R002SS16-120	120°	2,4	16	17,3	1	16	80	110	30	4	
7803404	PLDS11R002SS16-L120	120°	2,4	16	17,3	1	16	170	200	30	4	

Centering and Chamfering | Indexables



Accessories & spare parts

 Clamping screw	Designation	Recommended Tightening Torque	 Wrench	Designation
7808138	FS22550P (Torx 7IP)	1.0 N·m	7808224	7IP-D (Torx 7IP)

PLDS SF

Centering and Chamfering | Indexables

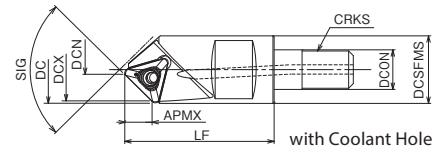

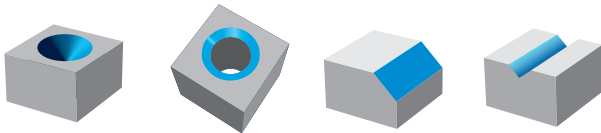

- Centering and Chamfering Cutter
- Screw Fit Type
- With coolant hole
- 14,4 - 17,3 mm



EDP	Designation	SIG	DCN	DCX	DC	ZEFP	DCON	CRKS	Spanner Size	OAL	DCSFMS	APMX	Price
7803405	PLDS11R002SF8-90	90°	2,5	13,5	14,4	1	8,5	M8	10	32	14,5	5,8	
7803406	PLDS11R002SF8-120	120°	2,4	16	17,3	1	8,5	M8	10	32	14,5	4	

Accessories & spare parts

 Clamping screw	Designation	Recommended Tightening Torque	 Wrench	Designation
7808138	FS22550P (Torx 7IP)	1.0 N-m	7808224	7IP-D (Torx 7IP)



PLDS INSERTS

Centering and Chamfering | Indexables

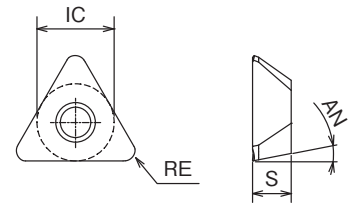

- Economical 3-corner inserts with both chipping resistance and sharpness

Centering and Chamfering | Indexables



Inserts

EDP	Designation	Z	IC	S	AN	RE	Grade	P		M		K		N		S		H		Prices
								dry	oil	dry	oil	GG	GGG	dry	oil	dry	oil	dry	oil	
7814205	TPKT110308ER-DM	3	6,35	3,18	11°	0,8	XP9020	oil	oil	oil	oil	GG	GGG	oil	oil	oil	oil	oil	oil	
7813205	TPKT110308ER-DM	3	6,35	3,18	11°	0,8	XP2040	oil	oil	oil	oil	GG	GGG	oil	oil	oil	oil	oil	oil	

CUTTING CONDITIONS

Centering and Chamfering | Indexables | Cutting conditions

PLDS

Centering and Chamfering Cutter

	Work Material	Tensile Strength / Hardness	Vc (m/min) Cutting Speed	(min ⁻¹) S	(mm/rev) Feed Rate	
					Centering	Countersinking (Side Feed)
P	Mild Steel-Carbon Steel (S5400-S10C)	~180HB	80 (60~120)	1.500 ~ 3.000	0,06 (0,03 ~ 0,08)	0,08 (0,05 ~ 0,12)
	Carbon Steel-Alloy Steel (S50C-SCM440)	~280HB	80 (60~120)	1.500 ~ 3.000	0,06 (0,03 ~ 0,08)	0,08 (0,05 ~ 0,12)
	Die Steel (SKD11-SKD61)	~280HB	80 (60~120)	1.500 ~ 3.000	0,06 (0,03 ~ 0,08)	0,08 (0,05 ~ 0,12)
M	Stainless Steel (Coolant) (SUS304-SUS420)	~250HB	80 (60~120)	1.500 ~ 2.500	0,06 (0,03 ~ 0,08)	0,08 (0,05 ~ 0,12)
K	Cast Iron (FC250)	~350N/mm ²	100 (60~140)	1.500 ~ 3.500	0,06 (0,03 ~ 0,08)	0,08 (0,05 ~ 0,12)
	Ductile Cast Iron (FCD400)	~800N/mm ²	100 (60~140)	1.500 ~ 3.500	0,06 (0,03 ~ 0,08)	0,08 (0,05 ~ 0,12)
N	Aluminium Alloys	~13%Si	150 (100~200)	2.500 ~ 5.000	0,06 (0,03 ~ 0,08)	0,08 (0,05 ~ 0,12)
S	Heat Resistant Alloys (Wet) (Inconel 718)	–	35 (25~60)	600 ~ 1.500	0,04 (0,03 ~ 0,06)	0,08 (0,05 ~ 0,12)
	Titanium Alloy (Wet) (Ti-6Al-4V)	–	40 (30~100)	700 ~ 2.500	0,06 (0,03 ~ 0,08)	0,08 (0,05 ~ 0,12)
H	Pre-hardened Steel (NAK80)	40~43HRC	80 (60~100)	1.500 ~ 3.000	0,06 (0,03 ~ 0,08)	0,08 (0,05 ~ 0,12)
	Steel for Die Casting (DAC-MAGIC, DH31)	43~48HRC	60 (50~80)	1.200 ~ 2.000	0,06 (0,03 ~ 0,08)	0,08 (0,05 ~ 0,12)

1. The above cutting conditions are to be used as general guidelines. Adjustments may be necessary depending on actual cutting condition.
2. Inserts should be attached to the holder tightly in a very neat condition.
3. Fasten the work material to reduce the possibility of work deformation, deflection of machined surface, or vibration.
4. For the feed of V slotting, use 80% of the countersinking (side feed) shown in the above table.

Centering and Chamfering | Indexables

Standard centering depth (H)

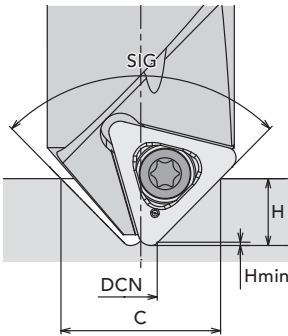

SIG = 90°
 Hmin = 0,25
 DCN = Ø 2,5 (minimum machined hole diameter)

$$H = (C - DCN) / 2 + Hmin$$

H = Centering depth
 C = Countersink diameter

Example: When SIG=90°C=φ10 (Countersink diameter)
 The value of H will be 4 mm instead of 5 mm.

SIG = 120°
 Hmin = 0,1
 DCN = Ø 2,4 (minimum machined hole diameter)

$$H = (C - DCN) / 3,46 + Hmin$$

H = Centering depth
 C = Countersink diameter

Cutting conditions

CUTTING DATA

Centering and Chamfering | Indexables

SUS304 90° Centering

Tool	PLDS11R002SS16-90
Insert Grade	TPKT110308ER-DM (XP2040)
Work Material	SUS304
Cutting Speed	63m/min (2.000min ⁻¹)
Feed	80mm/min (0.04mm/rev)
Processing depth	4mm Ø 10 Countersink diameter
Coolant	Water-Soluble (Internal)
Machine	Horizontal Machining Center

	Number of holes			
	100	200	300	400
PLDS	Still Running			
Competitor A	Chipping			
Competitor B	Chipping			

The PLDS exhibits good wear condition and can continue to be used even after machining more than twice the number of holes as the competitor products.



S50C 90° Centering

Tool	PLDS11R002SS16-90
Insert Grade	TPKT110308ER-DM (XP9020)
Work Material	S50C
Cutting Speed	94m/min (3.000min ⁻¹)
Feed	180mm/min (0.06mm/rev)
Processing depth	4mm Ø 10 Countersink diameter
Number of holes	700 Holes
Coolant	Water-Soluble (Internal)
Machine	Horizontal Machining Center

Wear comparison after machining 700 holes

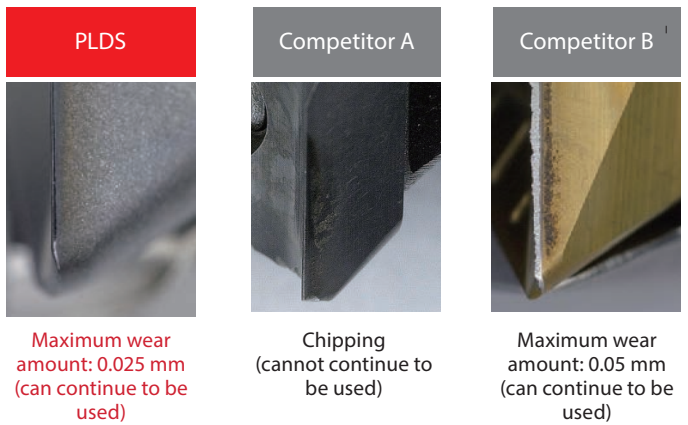

The PLDS exhibits minimal wear even after machining 700 holes and is in a state where it can continue to be used.

SWEDEN

Branch office of OSG SCANDINAVIA
Abrahams Gränd 8
295 35 Bromölla
Sweden
Tel: +46 40 41 22 55
osg@osg-scandinavia.com

OSG SCANDINAVIA

(For Scandinavian countries)
Langebjergvaenget 16
4000 Roskilde
Denmark
Tel: +45 46 75 65 55
osg@osg-scandinavia.com

OSG NETHERLANDS

Bedrijfsweg 5
3481 MG Harmelen
The Netherlands
Tel: +31 348 44 2764
Fax: +31 348 44 2144
info@osg-nl.com

OSG UK

Shelton house, 5 Bentalls
Pipps Hill Ind Est, Basildon Essex SS14 3BY
United Kingdom
Tel: +44 1268 567660
Fax: +44 1268 567661
sales@osg-uk.com

OSG EUROPE LOGISTICS

Avenue Lavoisier 1
B-1300 Z.I. Wavre - Nord
Belgium
Tel: +32 10 23 05 07
Fax: +32 10 23 05 51
info@osgeurope.com

OSG BELUX

Avenue Lavoisier 1
B-1300 Z.I. Wavre - Nord
Belgium
Tel: +32 10 23 05 11
Fax: +32 10 23 05 31
info@osg-belgium.com

OSG IBÉRICA

Bekolarra 4
E - 01010 Vitoria-Gasteiz
Spain
Tel: +34 945 242 400
Fax: +34 945 228 883
osg.iberica@osg-ib.com

OSG FRANCE

Parc Icade, Paris Nord 2
Immeuble "Le Rimbaud"
22 Avenue des Nations
CS66191 - 93420 Villepinte
France
Tel: +33 1 49 90 10 10
Fax: +33 1 49 90 10 15
sales@osg-france.com

OSG ITALY

Via Ferrero, 65 A/B
I - 10098 Rivoli
Italian
Tel: +39 0117705211
Fax: +39 0117705215
info@osg-italia.it





CZECH REPUBLIC, SLOVAKIA, HUNGARY

OSG Europe Logistics S.A.
Slovakia, organizačná zložka
Račianska 22/A, Bratislava 831 02
Slovakia
Tel.: +421 24 32 91 295
info@osgeurope.com

OSG POLAND

ul. Spółdzielcza 57
05-074 Halinów
Polska
Tel: +22 760 82 71
Mob. +48 570 677 711
osg@osg-poland.com

OSG RUSSIA

Butlerova street, 17B, office 5069
117342 Moscow
Russia
Tel: +7 (495) 150 41 54
info@osg-russia.com

ROMSAN INTERNATIONAL CO. SRL

Reprezentant Exclusiv OSG
Str. Nerva Traian Nr. 23-25
051431 Bucuresti, Sector 3
România
Tel: +40 21 322 07 47
Fax: +40 21 321 56 00
romsan.int@romsan.ro

OSG TURKEY

Rami Kışla Cad.No:56 Eyüp
İstanbul 34056
Turkey
Tel: +90 212 565 24 00
Fax: +90 212 565 44 00
info@osg-turkey.com

Vischer & Bolli AG

Machining and Workholding
Im Schossacher 17
CH-8600 Dübendorf
Schweiz
Tel.: +41 44 802 15 15
Fax: +41 44 802 15 95
info@vb-tools.com

OSG GERMANY

Karl-Ehmann-Str. 25
D - 73037 Göppingen
Germany
Tel: +49 7161 6064 - 0
Fax: +49 7161 6064 - 444
info@osg-germany.de



shaping your dreams

OSG EUROPE LOGISTICS

Avenue Lavoisier 1
B-1300 Z.I. Wavre - Nord - Belgium
Tel: +32 10 23 05 07
Fax: +32 10 23 05 51
info@osgeurope.com

OSG BELUX

Avenue Lavoisier 1
B-1300 Z.I. Wavre - Nord - Belgium
Tel: +32 10 23 05 11
Fax: +32 10 23 05 31
info@osg-belgium.com

OSG FRANCE

Parc Icade, Paris Nord 2
Immeuble "Le Rimbaud"
22 Avenue des Nations
CS66191 - 93420 Villepinte - France
Tel: +33 1 49 90 10 10
Fax: +33 1 49 90 10 15
sales@osg-france.com

OSG NETHERLANDS

Bedrijfsweg 5 - 3481 MG Harmelen
Tel: +31 348 44 2764
Fax: +31 348 44 2144
info@osg-nl.com

OSG UK

Shelton house, 5 Bentalls
Pipps Hill Ind Est, Basildon Essex SS14 3BY
Tel: +44 1268 567 660
Fax: +44 1268 567 661
sales@osg-uk.com

CZECH, SLOVAKIA, HUNGARY

OSG Europe Logistics S.A.
Slovakia organizacna zlozka
Racianská 22/A, SK-83102 Bratislava
Slovakia
Tel. +421 24 32 91 295
Orders-osgsvk@osgeurope.com

OSG POLAND Sp. z.o.o.

Spółdzielcza 57
05-074 Halinów - Poland
Tel: +22 760 82 71
Fax: +22 760 82 71
osg@osg-poland.com

OSG GERMANY

Karl-Ehmann-Str. 25
D - 73037 Göppingen - Germany
Tel: +49 7161 6064 - 0
Fax: +49 7161 6064 - 444
info@osg-germany.de

OSG SCANDINAVIA

(For Scandinavian countries)
Langebjergvaenget 16
4000 Roskilde - Denmark
Tel: +45 46 75 65 55
Fax: +45 46 75 67 00
osg@osg-scandinavia.com

SWEDEN

Branch office of OSG SCANDINAVIA
Abrahams Gränd 8
295 35 Bromölla - Sweden
Tel: +46 40 41 22 55
Fax: +46 40 41 32 55
osg@osg-scandinavia.com

OSG IBERICA

Bekolarra 4
E - 01010 Vitoria-Gasteiz - Spain
Tel: +34 945 242 400
Fax: +34 945 228 883
osg.iberica@osg-ib.com

RUSSIA

Butlerova street, 17B, office 5069
117342 Moscow - Russia
Tel: +7 (495) 150 41 54
info@osg-russia.com

OSG TURKEY

Rami Kişla Cad.No:56 Eyüp
Istanbul 34056 - Turkey
Tel:+90 212 565 24 00
Fax: +90 212 565 44 00
info@osg-turkey.com

ROMSAN INTERNATIONAL CO. SRL

Reprezentant Exclusiv OSG
Str. Nerva Traian Nr. 23-25
051431 Bucuresti, Sector 3 - România
Tel: +40 21 322 07 47
Fax: +40 21 321 56 00
romsan.int@romsan.ro

AUSTRIA

Branch office of OSG GERMANY
Messestraße 11
A-6850 Dornbirn
Tel: +49 7161 6064-0
Fax: +49 7161 6064-444
info@osg-germany.de

OSG ITALIA

Via Ferrero, 65 A/B
I - 10098 Rivoli - Italy
Tel: +39 0117705211
Fax: +39 0117705215
info@osg-italia.it

Vischer & Bolli AG

Machining and Workholding
Im Schossacher 17
CH-8600 Dübendorf
T +41 44 802 15 15
F +41 44 802 15 95
info@vb-tools.com

OSG EUROPE LOGISTICS S.A.

08/2020 - All rights reserved. © OSG Europe 2020.

The contents of this catalogue are provided to you for viewing only. They are not intended for reproduction either in part or in whole in this or other medium. They cannot be copied, used to create derivation work or used for any reason, by means without the express, written permission of the copyright owner. If prices are stated, they are netto unit-prices and any eventual tax(es) have to be added. The company is not responsible for any printing error in technical, price and/or any other data.

Tool specifications subject to change without notice.

www.osgeurope.com