

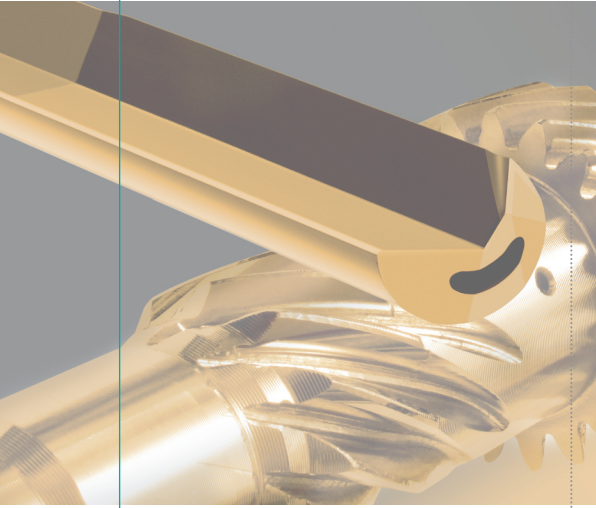

TBT Deep Hole Drilling
Tools, Accessories
and Grinding Machines



Across the world, our customers associate TBT Tiefbohrtechnik with reliability, quality, precision and customer proximity - and that for more than 50 years now.

The company has specialised in manufacturing technology for deep hole drilling since it was founded in Dettingen a.d. Erms in 1966. Our aim has always been to be an expert single-source provider of machines, tools and services.

Our rise to market leadership is confirmation that our customers acknowledge our corporate policy.

TBT Tiefbohrtechnik succeeds in combining the flexibility, dedication and customer-oriented approach of a lean, medium-sized enterprise with its presence on the global stage. We have subsidiaries or highly-experienced representatives in virtually all the major countries of the world. Your deep hole drilling requirements are safe in the hands of our highly-qualified, dedicated staff.



About us	2	Clamping sleeves (clamping elements)	18	Grinding machines	29
Procedures	6	Technical specifications	20	Universal grinding machine	29
Sealing case procedure	7	Surface quality	20	Tandem grinding machine	29
Immersion procedure	8	Runout	20	Grinding device	29
Procedures on machining centres	9	Cooling lubricants	21	Cutting data / reference values	30
Tools	10	Feed / cutting speed	21	Service	34
Single-lip drill, brazed	10	Accessories	22	Order form	34
Single-lip drill, solid carbide version	11	Drill bush	22	Directions, contact	36
Single lip drills with indexable inserts	12	Drill bush holder	23		
Cutting edge geometry	14	Sealing disc	24		
Contours	15	Whip guide bush	25		
Special tools	16	Sealing case	26		
High-speed tools	16	Other accessories	27		
Step drill	17	Clamping cone	27		
		Tool holder	27		
		Tool setting device	28		



Quality is the cornerstone of our corporate philosophy, shaping both our services and our products. Our stated aim is to manufacture our products to the highest standard in line with your specific requirements. Just as the market so rightly expects!

Being a certified company in compliance with DIN EN ISO 9001:2000 and VDA 6.4 is proof that our operational sequences are properly structured and that our quality management system is implemented and practised at all levels of the company. With the certificate ISO 14001 we prove our resource-efficient way of working and our responsibility towards our environment.

We see ourselves as your partner. Therefore, we aspire to a long-term working relationship with you. We seek an open and frank dialogue that will allow us to merge the expertise and experience present in both our companies, resulting in integrated and practical solutions. Thanks to our dedicated staff, we are able to guarantee that your order will be carried out on time and exactly as required.



HIGH-PERFORMANCE PRECISION DRILLING

TBT has been instrumental in shaping and developing deep hole technology. Thanks to the diameter tolerances it achieves, the surface quality and the minimum level of drift, the single-lip drill has proven its value in the area of high-performance precision drilling. In a number of applications, therefore, the deep hole drill principle replaces drilling and reaming with one pass. And it does so at a superior level of process reliability.

However, it doesn't always have to be only deep hole drilling. With its combination of precision and superior drilling performance, the single-lip drill is also eminently suited to work on short and intricate holes.

Single-lip drills are single-edge tools that are guided through a drill bush during their initial drilling phase. These drills can be used not only for deep hole drilling machines but also, for example, for machining centres or automatic lathes. The cooling lubricant moves from the machine to the tool cutting edge through the inside of the tool. In addition to cooling and lubricating the drill head, the pressurised lubricant flushes the chips out of the drill hole.

Deep hole drilling is, therefore, a reliable and efficient means of achieving precision drilling results.

TBT single-lip drills are manufactured to suit any drill diameter (1/1000 mm graduation) between 0.7 mm and far above 50 mm and for total lengths of up to approx. 6000 mm.

We develop and manufacture the tools to meet your requirements, taking into consideration the material to be drilled, the machinery to be used by the customer and the specific drilling situation. It may be a standard tool or one for counterboring existing holes, it may be a step tool for creating precise stepped bores with a minimum centre offset or a special tool for a specific bore surface; it may have no coating or may have a coating and, for high-end requirements, it may have a PCD-tipped tool cutting edge.

TBT is happy to advise you and to fulfil your drill head and shank requirements consistently and without delay, using state-of-the-art design and production procedures. The tool head and shank will be brazed to a clamping sleeve suitable for your machine.

TBT has hundreds of different clamping sleeves in stock at any one time. We also offer a 48-hour service.

SEALING CASE PROCEDURE

With the sealing case procedure, single-lip solid drill tools are used with a diameter range between 1.9 mm and approx. 50 mm. As the tool lengths can be up to 6000 mm, the tools are guided through steady rests. The clearances between the steady rests should be no wider than $40 - 50 \times \text{tool } \varnothing$.

The machine spindle is sealed by the sealing case or the sealing disc inside the case.

The cooling lubricant is supplied through one or more of the holes inside the tool.

The cooling lubricant / chip mixture is discharged through a longitudinal slot (bead) on the outside of the tool shank.

The cutting edge spans the radius of the hole to be drilled. The tool consists of the drill head, beaded shank and the clamping element (sleeve). The "classic" solid single-lip drill has a solid carbide head into which the cutting edge and the guide pads are ground.

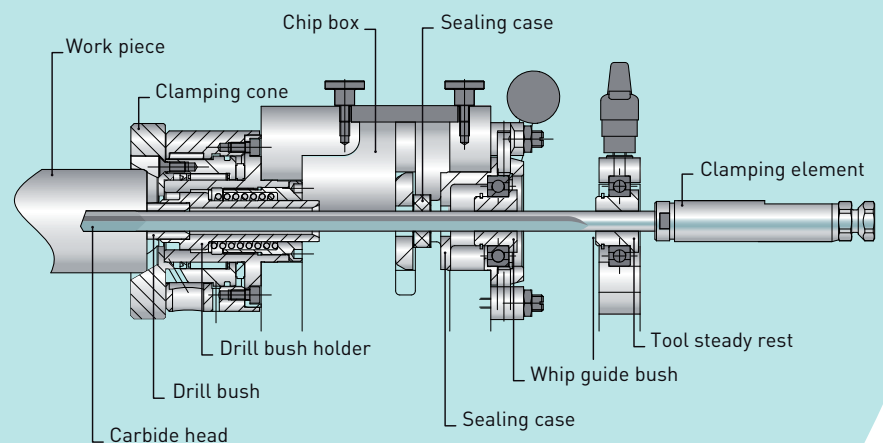

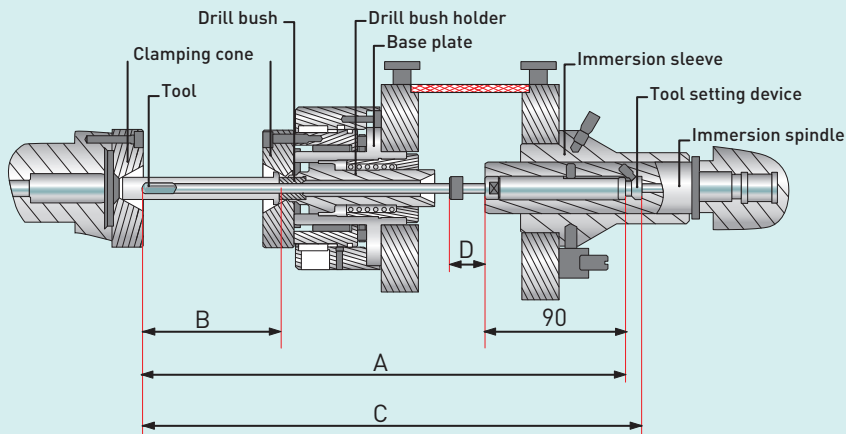

- A Tool length
- B Drill depth
- C Reference dimension
- D Adjustment distance depending on drill diameter

IMMERSION PROCEDURE FOR SHALLOW DRILLING DEPTHS

Single-lip solid bore tools are used for the diameter range of 0.7 mm to 50 mm. As steady rests are not used, the drill depth in the immersion procedure is limited to a maximum of 160 mm.

This procedure is suited primarily for drilling shallow holes. Tools of less than 2 mm \varnothing are made entirely of carbide. Solid carbide tools are increasingly used for the diameter range between 2 mm and 12 mm and for relatively shallow drill depths.

The machine spindle is sealed by the immersion sleeve or the immersion spindle.

The cooling lubricant is supplied through one or more of the holes inside the tool. The cooling lubricant/chip mixture is discharged through a longitudinal slot (bead) on the outside of the tool shank.

The cutting edge spans the radius of the hole to be drilled. The tool consists of a drill head, a beaded shank and the clamping element (sleeve). The "classic" solid single-lip drill has a solid carbide head into which the cutting edge and the guide pads are ground.

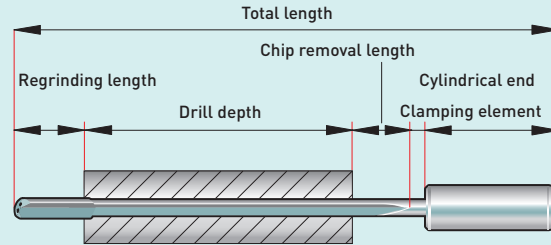

Length calculation

The trend towards multi-station machining has resulted in single-lip drills being used increasingly on conventional machine tools, for example on machining centres. With its combination of precision and superior drilling performance, the single-lip drill is also used for short and intricate holes.

Unlike deep hole drilling machines, drill bushes are only very seldom used in conventional machine tools. As a result, a pilot hole has to be drilled in the work piece first if a single-lip drill is to be used.

This hole has to meet specific requirements, for example, regarding diameter tolerance or guide length. Our expert team at TBT will be happy to advise you on the appropriate tools from the TBT range, for example single-lip drill, step drill or solid carbide drill, from the TBT range, for example single-lip drill, step drill, solid carbide drill and with indexable inserts.

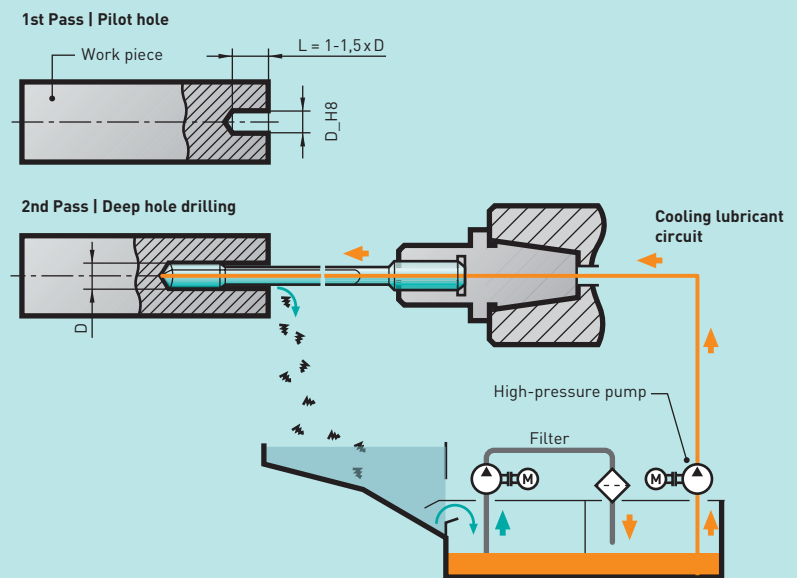

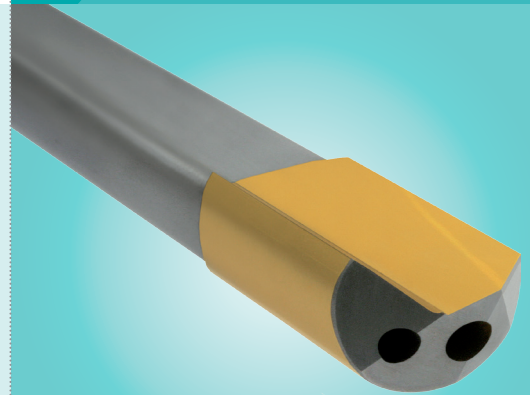
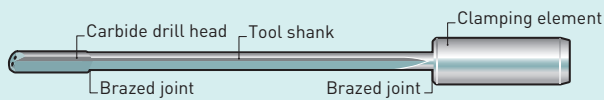

SINGLE-LIP DRILL WITH BRAZED DRILL HEAD

Single-lip drills with a brazed drill head consist of a drill head made of solid carbide or steel with carbide inserts, a drill shank made of hardened and tempered steel and a steel clamping sleeve. The drill head and the clamping sleeve are brazed to the tool shank.

Diameter range:	1.9 – 50.0 mm
Length:	up to 6000 mm
Effective tool length:	40 – 50 x D
Cooling lubricant required	
deep hole drilling oil preferred	
Filter resolution:	10 – 20 µm
Viscosity:	Ø 1.9 – 50 mm = 10 – 20 mm ² /S

Safety information

We shall accept no liability for damage resulting from the improper handling of our deep hole drilling tools, from operating errors, deficient machine conditions or from the improper use of our tools. All relevant application, emission and safety guidelines and regulations must be observed.

We will be happy to advise you!

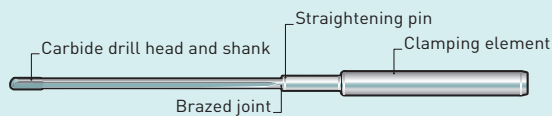

SOLID CARBIDE SINGLE-LIP DRILLS

The drill head and shank are made of a single carbide slug. This tool is particularly process reliable and efficient. A longer useful life is achieved due to the low level of torsional vibration.

The clamping element (steel) for this type of tool is made with a straightening pin. The clamping sleeves and drill shank are brazed together.

Diameter range:	0.7 – 12.0 mm
Length:	up to 600 mm
Effective tool length:	80 – 100 x D
Cooling lubricant required	
deep hole drilling oil preferred	
Filter resolution:	5 – 10 µm
Viscosity:	∅ 0.8 – 2.0 mm = 7 – 10 mm ² /S ∅ 2.0 – 12 mm = 10 – 20 mm ² /S

Safety information

We shall accept no liability for damage resulting from the improper handling of our deep hole drilling tools, from operating errors, deficient machine conditions or from the improper use of our tools. All relevant application, emission and safety guidelines and regulations must be observed.

We will be happy to advise you!

TOOLS: SINGLE LIP DRILLS WITH INDEXABLE INSERTS

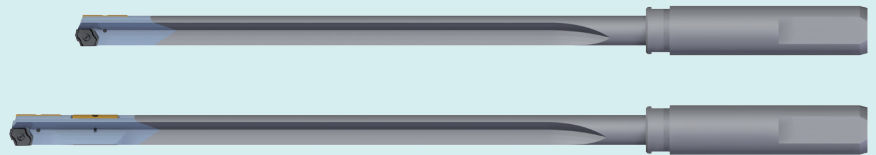
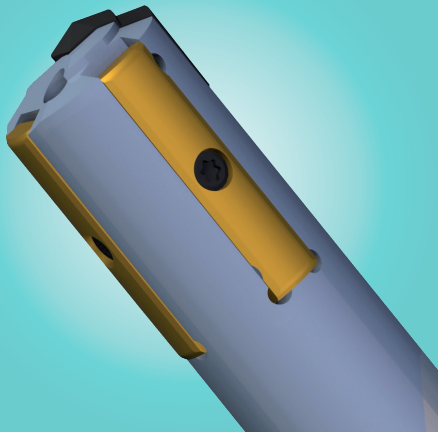

Main Features:

1. **High efficiency** by specifically developed cutting edge geometry for optimal chip formation.
2. **Short downtime** resulting from quick exchange of wear parts on the clamped tool.
3. **Easy to use**, no sharpening, no length adjustment, easy inventory of wear parts.
4. **Long tool life** due to full coating and edge treatment
5. **Quick availability** due to stocked wear parts.

Material	cutting speed		feed rate mm / rev		
	Vc m/min	Ø 12,00-17,99 mm	Ø 18,00 - 24,99 mm	Ø 25,00 - 28,00 mm	
Construction steel < 700/mm ²	80 - 100	0,055 - 0,100	0,080 - 0,110	0,100 - 0,140	
Case hardened steel < 700/mm ²	80 - 100	0,055 - 0,100	0,080 - 0,110	0,100 - 0,140	
Case hardened steel < 1100/mm ²	70 - 80	0,070 - 0,100	0,080 - 0,110	0,100 - 0,130	
Heat treated steel < 700/mm ²	70 - 90	0,070 - 0,100	0,080 - 0,110	0,100 - 0,140	
Heat treated steel < 1100/mm ²	55 - 75	0,070 - 0,100	0,080 - 0,110	0,100 - 0,130	
Nitriding steel < 1100/mm ²	55 - 75	0,070 - 0,090	0,080 - 0,100	0,090 - 0,120	
Ferritic steel < 900/mm ²	60 - 80	0,070 - 0,100	0,080 - 0,110	0,100 - 0,140	
Austenitic steel	60 - 80	0,070 - 0,090	0,080 - 0,100	0,100 - 0,120	
Heat resisting steel, Tool steel	50 - 70	0,070 - 0,090	0,080 - 0,100	0,100 - 0,120	
Steel castings < 700/mm ²	60 - 80	0,070 - 0,100	0,080 - 0,110	0,100 - 0,140	
Nodular cast iron < 700/mm ²	65 - 80	0,090 - 0,120	0,100 - 0,130	0,120 - 0,150	
Cast iron, alloyed and unalloyed	70 - 100	0,090 - 0,120	0,100 - 0,130	0,120 - 0,150	
Aluminium	100 - 200	0,080 - 0,110	0,090 - 0,120	0,100 - 0,140	
Copper Cu-content < 99%	120 - 300	0,050 - 0,090	0,060 - 0,100	0,080 - 0,120	

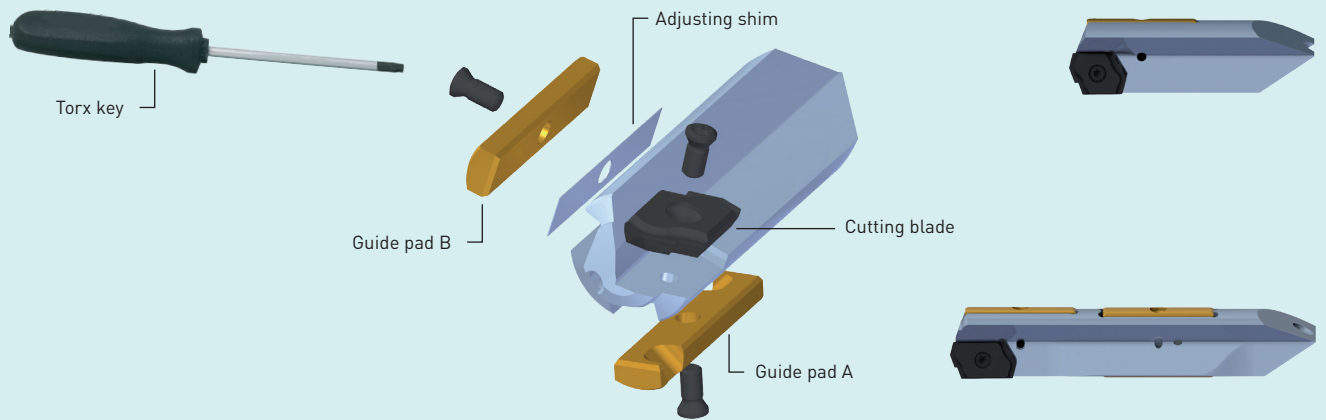

Design

- » Current diameter range: 12.00 mm – 28.00 mm
- » Cutting blade & guide pads fully coated
- » Covering the whole diameter range with only 6 sizes of cutting blades
- » Body in steps of 0.1 mm
- » Available with a long head and three additional guide pads.
- » Adjusting shim ranging from 0.1 to 0.2 mm in steps of 0.02mm

Select your wear parts in the following table:

From Ø	To Ø	Indexable cutting insert	Guide pads		Adjusting shim set	Torx screw	Torx key
12,00	13,94	TSTS-CB-00	TSTS-GC04-P	TSTS-GC04A-P	TSTS-S04	TSTS-SGI-M2.2	TSTS-SD-7
13,95	15,00	TSTS-CB-01	TSTS-GC05-P	TSTS-GC05A-P	TSTS-S05		
15,01	16,50	TSTS-CB-02	TSTS-GC05-P			TSTS-SGI-M2.5	TSTS-SD-8
16,51	17,30	TSTS-CB-02	TSTS-GC05-P			TSTS-S06	TSTS-SGI-M3
17,31	19,70	TSTS-CB-05	TSTS-GC06-P				
19,71	23,80	TSTS-CB-07	TSTS-GC06-P				
23,81	28,00	TSTS-CB-08	TSTS-GC06-P				

CUTTING EDGE GEOMETRY

Symbol	Axis A	Axis B	Axis C	Measure	Comment
1	-30°	+12°	+5°	>D/4	Set Axis C such that the chamfer during the second pass is parallel to the chip face. The width of the chamfer is the same as that of the circular grinding chamfer.
2	-30°	+20°	+6,5°	Fase 0,3...0,5	
3	+20°	+12°	-5°	D/4	
4	+30°	+12°	+55°		
5	0°	+25°	-5°		
6					

[There may be slight deviation in measurement due to angle distortion]

Changes to the cutting edge geometry of the single-lip drill could affect the drilled surface, the chip shape, drilling tolerance, drill centring, chip removal, surface quality or useful life.

Virtually all drilling tasks can be executed successfully with TBT standard grind facets. Generally speaking, special grind facets, sometimes with a chip separator / chip breaker are required when deep drilling particularly long-chipping materials or materials that are difficult to machine. We already manufacture and develop a wide range of grind sections or manufacture them to customer specifications. The standard grind facets for TBT single-lip drills depend on the drill diameter and the material to be drilled. We recommend TBT universal and tandem grinding machines for regrinding tools.

Symbol	Axis A	Axis B	Axis C	Measure	Comment
1	-40°	+25°	+12°	>D/4	Twist the single-lip drill lightly around the circumference without damaging the guide chamfer!
2	+30°	+20°	-7°	D/4	
3	+35°	+20°	+55°		
4	0°	+38°	0°		
5					

[There may be slight deviation in measurement due to angle distortion]

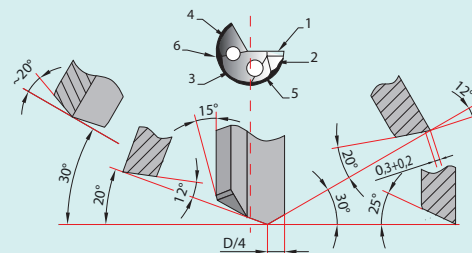

Standard grind section for single-lip drills with Ø = 5 to 30 mm

Changes to the cutting edge geometry will have a direct effect on bore quality and process reliability.

TBT cutting edge geometry is the result of over 50 years of research and development work by our machine engineering, tool design and machining service departments.

With our cutting edge geometries, no job is too difficult!

Make use of our experience for your drilling jobs!

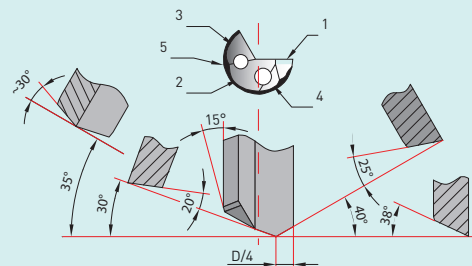

Standard grind section for single-lip drills up to 5 mm

STANDARD CONTOURS

TBT-developed contours are specially tailored to individual applications.

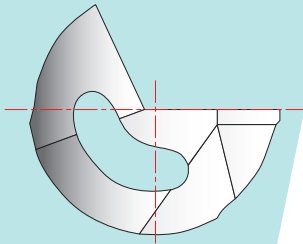

Contour G60

Standard contour suitable for most materials and drilling jobs. With this contour, the tool diameter can no longer be measured after manufacturing.

The standard starting point for the guide pad is 60°, but can range from 45° to 80°.

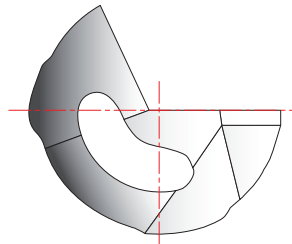

Contour C

This is the preferred contour for narrow tolerances in terms of bore diameter and surface. Some of the guide pads are convex ground. The circular grinding chamfer can protrude over the guide pads.

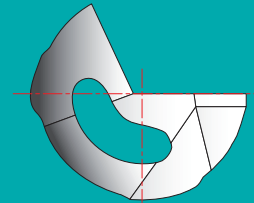

Contour S

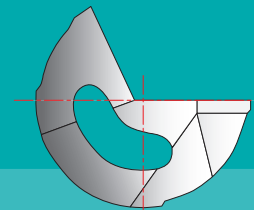

Contour EA

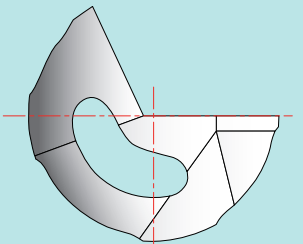

Contour A

Contour for unfavourable drilling conditions when drilling or for cross-drilling. Machining soft materials or with a poorly-performing cooling lubricant. Is often used at the cylindrical guide part (long drill head).

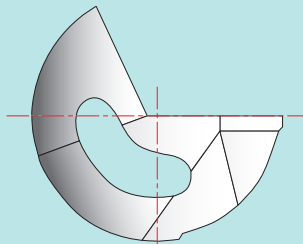

Contour D45

This contour is used almost exclusively for soft materials such as grey cast iron, graphite, ..., particularly in connection with narrow bore tolerances.

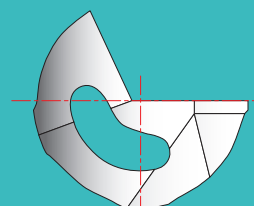

Contour F

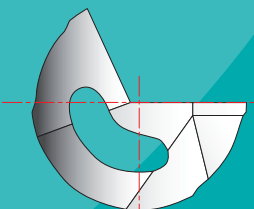

Contour GA80

Patented HS cutting edge geometry

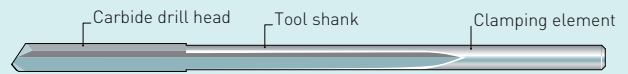
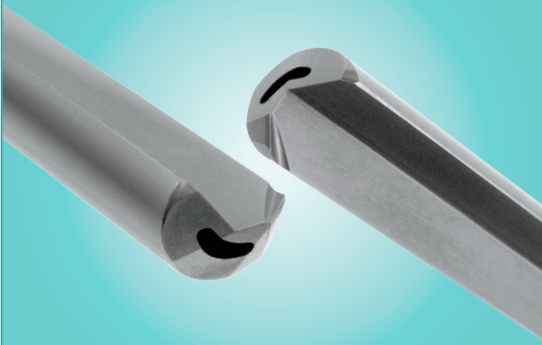

HIGH-SPEED SINGLE-LIP DRILL

Innovative TBT high-speed cutting edge geometry, precision-ground tool surface and ultra smooth coating due to own top finishing allows for feed speeds of up to factor 5 compared with conventional carbide single-lip drills. We will be happy to provide further information on request.

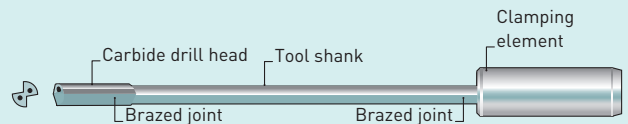
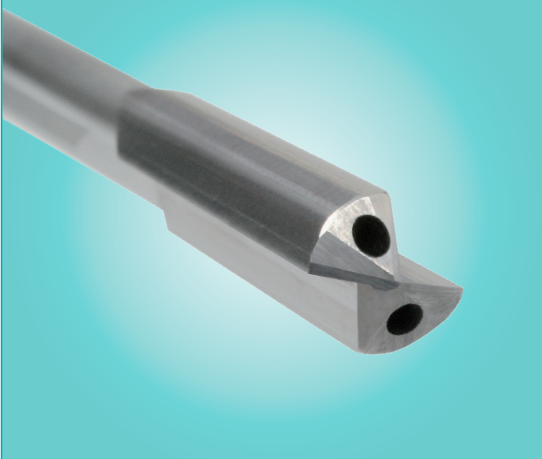

DOUBLE-LIP DRILL

Double-lip drilling – a procedure related to deep hole drilling – is used for diameter ranges of 6 to 25 mm and for l/d ratios of up to maximum 30 to 40. The tools are double-edged and generally have two guide pads in addition to the two circular grinding chamfers. These tools are made of solid carbide or a solid carbide drill head and steel tube or a solid steel shank. Due to their smaller flute, these tools should be used preferably for short-chipping materials.

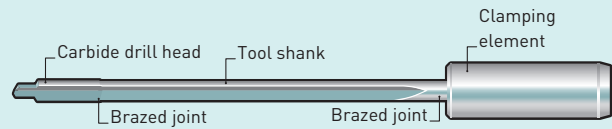
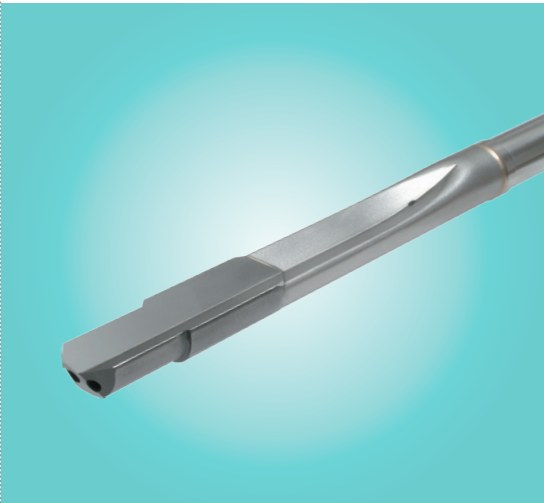

SINGLE-LIP STEP DRILL

Used where several bore diameters are included in one pass. Meets the strictest requirements in terms of concentricity and coaxiality.

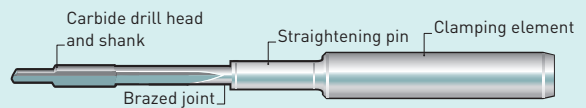
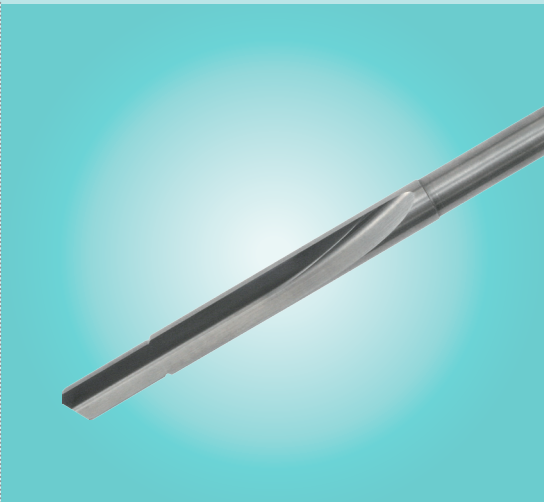

SOLID CARBIDE SINGLE-LIP STEP DRILL

Used where several bore diameters are included in one pass. Meets the strictest requirements in terms of concentricity and coaxiality.

CLAMPING SLEEVES

OVERVIEW – CLAMPING ELEMENTS

Clamping sleeves

In addition to a wide range of standard clamping sleeves, TBT also manufactures bespoke clamping sleeves in accordance with your specifications (drawing or sample).

Name	Diagram	L1	L2	X	M	Drill range	Article number
∅ 10 x 40		40	46	24,3		1,900 - 7,099	5009000
∅ 16 x 45		45	53	31		1,900 - 12,099	5006872
∅ 16 x 50		50	58	47,5		1,900 - 12,099	5008000
∅ 25 x 70		70	78	34		1,900 - 19,799	5007000
∅ 10 x 40		42	55	24,3		7,100 - 9,999	5005026
∅ 16 x 45		45	65	31		11,400 - 14,949	5005519
∅ 16 x 50		52	75	47,5		11,400 - 14,949	5005004
∅ 25 x 70		72	105	34		19,800 - 23,799	5005003
∅ 25,4 x 69,8		69,8		57,1		1,900 - 19,799	5005011
∅ 31,75 x 69,8		69,8		57,1		1,900 - 25,999	5005022
∅ 38,1 x 69,8		69,8		57,1		1,900 - 30,999	5005024
∅ 12,7 x 38,1		38,1	58	25,4		8,300 - 12,499	5005962
∅ 19,05 x 69,8		69,8	100	44,4		14,95 - 18,799	5005529
∅ 25,4 x 69,8		69,8	105	57,1		19,8 - 24,799	5005339
∅ 31,75 x 69,8		69,8	100	57,1		26,0 - 30,999	5005193
∅ 38,1 x 69,8		69,8	100	57,1		33,0 - 40,0	5006386
∅ 10 x 68		68		35	M6 x 0,5	1,9 - 6,799	5006093
∅ 16 x 90		90		37	M10 x 1	1,9 - 12,099	5006094
∅ 25 x 112		112		45	M16 x 1,5	1,9 - 19,799	5006095
∅ 10 x 68		68	81	35	M6 x 0,5	6,8 - 9,999	5006196
∅ 16 x 90		90	110	37	M10 x 1	11,4 - 14,949	5006197
∅ 25 x 112		112	142	45	M16 x 1,5	19,8 - 24,799	5006198
∅ 10 x 40		40				1,9 - 6,499	5006914
∅ 12 x 45		45				1,9 - 7,999	5006719
∅ 16 x 48		48				1,9 - 11,399	5005802
∅ 20 x 50		50				1,9 - 14,949	5006518
∅ 25 x 56		56				1,9 - 19,799	5006519
∅ 32 x 60		60				1,9 - 25,999	5006960
		DIN 6535 Form HA					

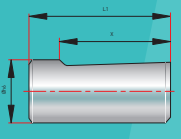
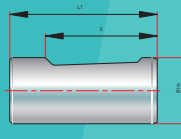
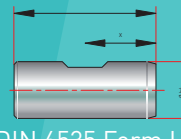
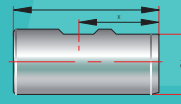
Name	Diagram	L1	L2	X	M	Drill range	Article number
∅ 10 x 40	 DIN 1835 Form E	40	28			1,9 - 7,099	5006158
∅ 12 x 45		45	33			1,9 - 7,999	5005822
∅ 16 x 48		48	36			1,9 - 11,399	5005872
∅ 20 x 50		50	38			1,9 - 14,949	5005821
∅ 25 x 56		56	44			1,9 - 19,799	5005583
∅ 32 x 60		60	48			1,9 - 25,999	5005861
∅ 10 x 40	 DIN 6535 Form HE	40	28			1,9 - 6,499	5006487
∅ 12 x 45		45	33			1,9 - 7,999	5006458
∅ 16 x 48		48	36			1,9 - 11,399	5006501
∅ 20 x 50		50	38			1,9 - 14,949	5006505
∅ 25 x 56		56	44			1,9 - 19,799	5006491
∅ 10 x 40	 DIN 6535 Form HB	40	20			1,9 - 7,099	5005914
∅ 12 x 45		45	22,5			1,9 - 7,999	5006061
∅ 16 x 48		48	24			1,9 - 11,399	5005911
∅ 20 x 50		50	25			1,9 - 14,949	5005886
∅ 25 x 56		56	32			1,9 - 19,799	5005887
∅ 32 x 60	 DIN 6535 Form HB	60	36			1,9 - 25,999	5006234
∅ 40 x 70		70	40			1,9 - 29,999	5006239

Clamping elements for VHM-tools

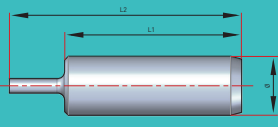
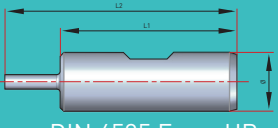
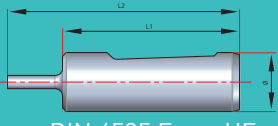
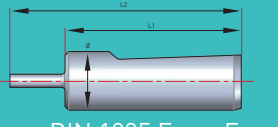
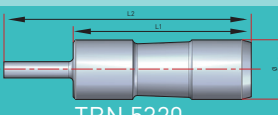
4 x 34 x 46	 DIN 6535-HA	34	46			0,500 - 5,800	5006878
6 x 36 x 51		36	51			0,500 - 5,800	5008255
10 x 40 x 55		40	55			0,500 - 7,000	5008126
12 x 45 x 60		45	60			0,500 - 8,300	5007374
16 x 48 x 63		48	63			0,500 - 10,000	5008018
6 x 36 x 51	 DIN 6535 Form HB	36	51			0,500 - 5,800	5008827
10 x 40 x 55		40	55			0,500 - 7,000	5007159
12 x 45 x 60		45	60			0,500 - 8,300	5007726
16 x 48 x 63		48	63			0,500 - 10,000	5007260
6 x 36 x 51	 DIN 6535 Form HE	36	51			0,500 - 5,800	5008450
10 x 40 x 55		40	55			0,500 - 7,000	5007156
12 x 45 x 60		45	60			0,500 - 8,300	5008462
16 x 48 x 63		48	63			0,500 - 10,000	5007808
6 x 36 x 51	 DIN 1835 Form E	36	51			0,500 - 5,800	5008828
10 x 40 x 55		40	55			0,500 - 7,000	5007328
12 x 45 x 60		45	60			0,500 - 8,300	5008829
16 x 48 x 63		48	63			0,500 - 10,000	5008471
12,7x38,1x53	 TBN 5320	38,1	53			0,500 - 8,300	5007536

		>			>>			>>>			>>>>		
Title		N12	N11	N10	N9	N8	N7	N6	N5	N4	N3	N2	N1
Twist drilling				X	X	X							
Reaming						X	X	X	X	X			
Broaching						X	X	X	X				
Honing							X	X	X	X	X	X	
Deep hole drilling								X	X	X	X		
Arithmetical mean roughness Ra	µm	50	25	12,5	6,30	3,20	1,60	0,80	0,40	0,20	0,10	0,05	0,025

Surface quality (reference values)

SURFACE QUALITY

The radial energy generated during drilling is transferred to the bore wall through the guide pads, resulting in the surface being pressed smooth.

This effect can be increased even more by adjusting the design of the guide pads, giving an outstanding surface quality.

Diameter tolerance

Diameter tolerances of up to IT 7 can be achieved in production with TBT single-lip drills.

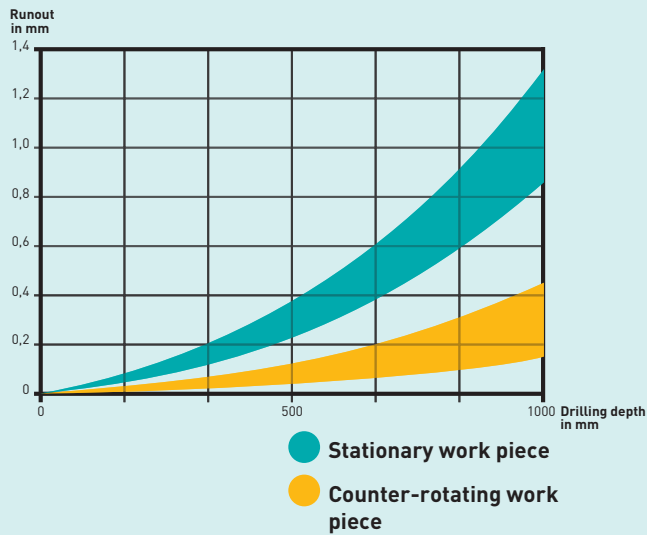

Runout (reference values)

RUNOUT

As a result of the drill bush or the pilot bore on the work piece together with the bore itself, the single-lip drill achieves precision, restricted guidance, and the drift is, therefore, kept to a minimum.

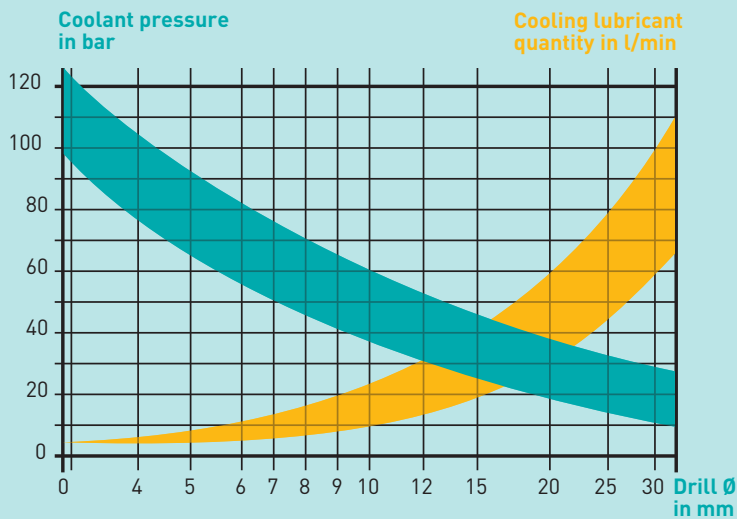

Cooling lubricants (reference values)

COOLING LUBRICANTS

An efficient and correctly dimensioned coolant system and filter are required in order to ensure the economic viability and process reliability of deep hole drilling. A further consideration is the requirement to adhere to a minimum level of fat content (depending on the material) when using emulsion. We recommend the use of deep hole drilling oil for small drill diameters and high-alloy steels.

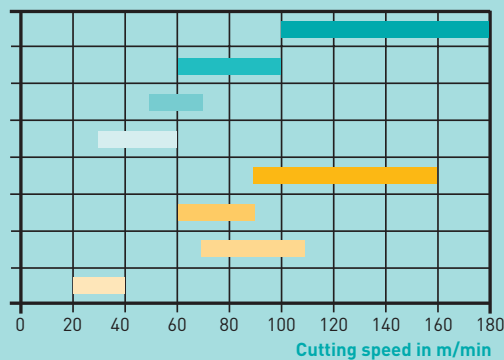

- Cast aluminium
- Grey cast iron
- Nitriding steel
- Heat / corrosion-resistant steels
- Aluminium alloy, non-ferrous metals
- Tempered steel
- Case-hardened steel
- Titanium, Nickel, Inconel, Hasteloy

Cutting speed (reference values)

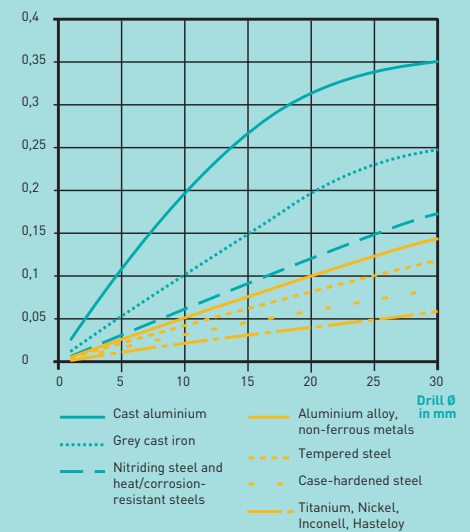

Feed (reference values)

CUTTING SPEED

Please see the tables on pages 30 – 33 for details of the various cutting speeds and feed values.

ACCESSORIES: DRILL BUSHES

22

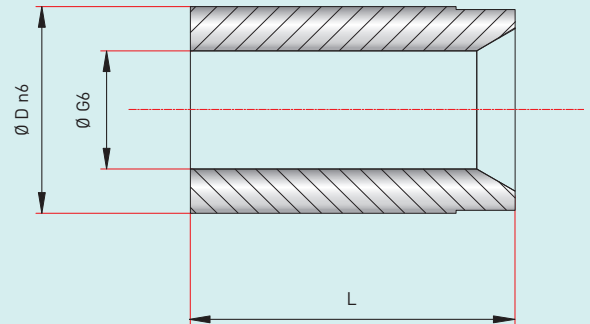
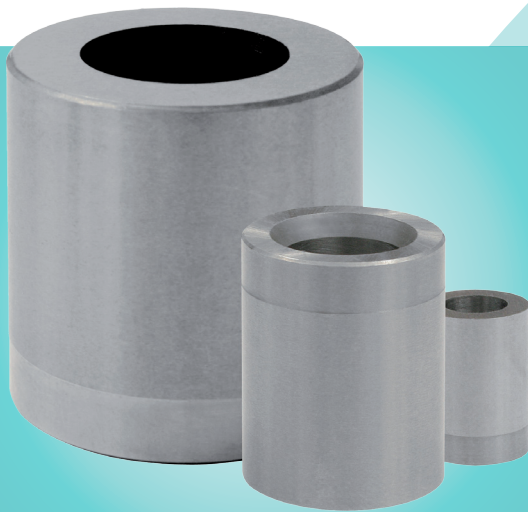

Machining accessories, drill bush

Centring guide at the start of drilling until the tool centres itself in the hole.

Available in steel or carbide.

Drill Bushes according to TBT standard ensure a safe and smooth chip evacuation.

DRILL BUSHES STEEL / CARBIDE VERSION

TBT standard steel/carbide	Tool-Ø		D n6	L	Ø G6
TBN 2302/2310	0,900	0,999	3	8	Please state tool Ø when ordering.
TBN 2302/2310	1,000	1,899	4		
TBN 2302/2310	1,900	2,699	5		
TBN 2302/2310	2,700	3,399	6	11	
TBN 2302/2310	3,400	4,099	7		
TBN 2302/2310	4,100	5,099	8		
TBN 2302/2310	5,100	6,099	10	14	
TBN 2302/2310	6,100	8,099	12		
TBN 2302/2310	8,100	10,099	15	18	
TBN 2302/2310	10,100	12,099	18		
TBN 2302/2310	12,100	15,099	22	26	
TBN 2302/2310	15,100	18,099	26		
TBN 2302/2310	18,100	22,099	30	33	
TBN 2302/2310	22,100	26,099	35		
TBN 2302/2310	26,100	30,099	42		
TBN 2302/2310	30,100	35,099	48	42	
TBN 2302/2310	35,100	42,099	55		
TBN 2302/2310	42,100	48,099	62	52	
TBN 2302/2310	48,100	55,099	70		
TBN 2302/2310	55,100	63,000	78	67	

Please note when ordering:

Example of order: drill bush Ø 5.0 steel

Order text: drill bush as per TBN 2302 5.0 x 8 x11

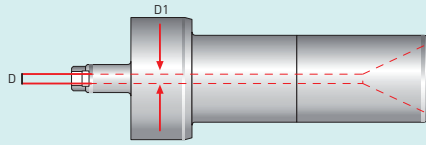

Drill bush holder

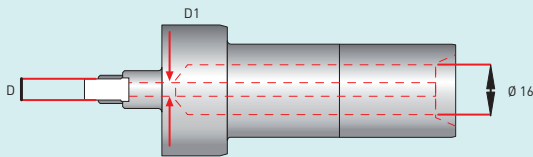

Machining accessories, drill bush holder

Holds the drill bush in place for positioning on the work piece.

DRILL BUSH HOLDER

from	Drill range	to	øD
1,000		1,899	4
1,900		2,699	5
2,700		3,399	6
3,400		4,099	7
4,100		5,099	8
5,100		6,099	10
6,100		8,099	12
8,100		10,099	15
10,100		12,099	18
12,100		15,099	22
15,100		18,099	26
18,100		22,099	30
22,100		26,099	35
26,100		30,099	42
30,100		35,099	48
35,100		42,099	55
42,100		48,099	62
48,100		55,099	70
55,100		63,000	78

Please note when ordering:

Please state the machine number and drill diameter when ordering.

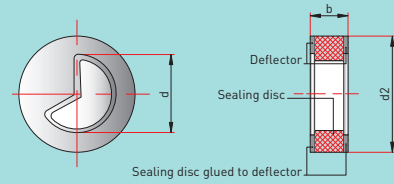
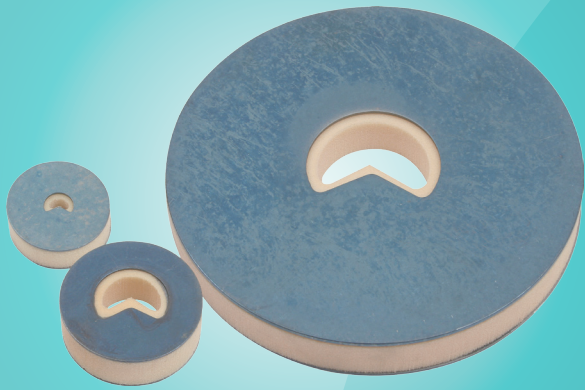

Sealing disc TBN 5404

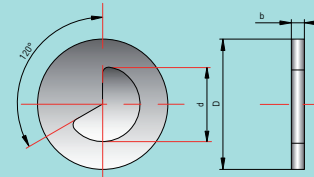

Sealing disc TBN 5416

Machining accessories, sealing disc

Forms a seal between the chip box and the spindle

COMPOSITE SEALING DISC TBN 5404

TBT standard	Tool Ø	d2	b	d
TBN 5404	2,900 - 5,249	20	7	Please state tool Ø when ordering.
TBN 5404	5,250 - 16,399	32	11	
TBN 5404	16,400 - 25,999	40	12	
TBN 5404	14,550 - 40,999	90	12	

VULKOLLAN SEALING DISC TBN 5416

TBT standard	Tool Ø	D	b	d
TBN 5416	2,000 - 6,499	20	4	Please state tool Ø when ordering.
TBN 5416	4,800 - 20,799	32	4	
TBN 5416	6,500 - 25,999	40	4	
TBN 5416	26,000 - 41,000	90	4	

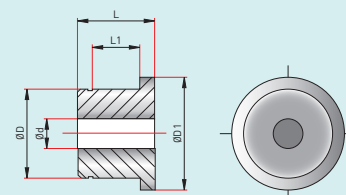

Whip guide bush

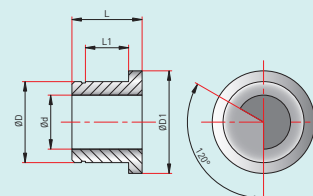

Form whip guide bush

Machining accessories, whip guide bush

For guiding and stabilising the tool

WHIP GUIDE BUSHES

TBT standard	Tool Ø	D	D1	L	L1	d
TBN 5406	1,900 - 16,399	20	26	20	12	Please state tool Ø when ordering.
TBN 5407	1,900 - 25,999	30	38	26	16	
TBN 5412	1,900 - 35,999	45	50	26	16	

FORM WHIP GUIDE BUSHES

TBT standard	Tool Ø	D	D1	L	L1	d
TBN 5420	2,000 - 12,449	20	26	20	12	Please state tool Ø when ordering.
TBN 5421	3,100 - 23,799	30	38	26	16	
TBN 5422	5,650 - 33,699	45	50	26	16	

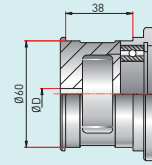
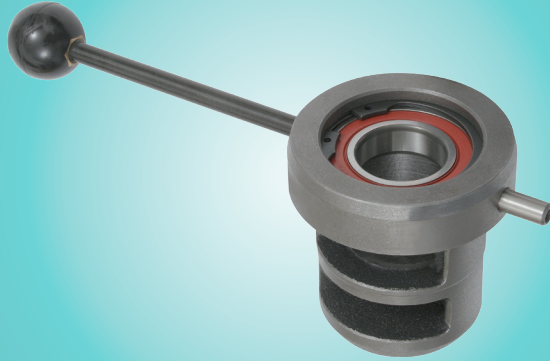

Sealing case 100700-7101-01

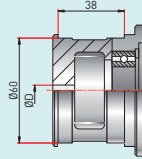

Sealing case 302200-7101-01

Machining accessories, sealing case: Houses the sealing disc and whip guide bush.

302200-7101-01

Sealing case for whip guide bushes \varnothing 20 without bearing

Article number	Drill range		\varnothing D
	from	to	
302200-7101-01	1,900	5,249	6,5
302200-7102-01	5,250	11,399	12,5
302200-7103-01	11,400	16,399	18,5

Sealing case for whip guide bushes \varnothing 20 with bearing

Article number	Drill range		\varnothing D
	from	to	
302200-7101-00	1,900	5,249	6,5
302200-7102-00	5,250	11,399	12,5
302200-7103-00	11,400	16,399	18,5

100700-7101-01

Sealing case for whip guide bushes \varnothing 30 without bearing

Article number	Drill range		\varnothing D
	from	to	
100700-7101-01	1,900	5,249	6,5
100700-7102-01	5,250	11,399	12,5
100700-7103-01	11,400	16,399	18,5
100700-7104-01	16,400	25,999	27

Sealing case for whip guide bushes \varnothing 30 with bearing

Article number	Drill range		\varnothing D
	from	to	
100700-7101-00	1,900	5,249	6,5
100700-7102-00	5,250	11,399	12,5
100700-7103-00	11,400	16,399	18,5
100700-7104-00	16,400	25,999	27

Please note when ordering: Please state machine number and drill diameter when ordering.

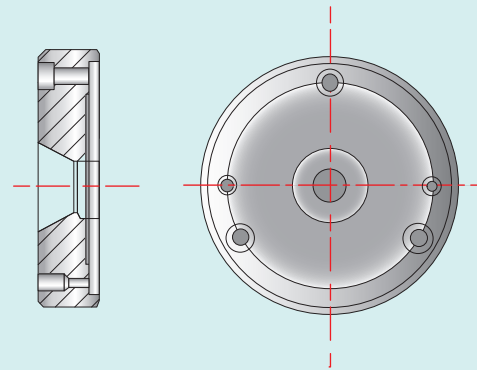
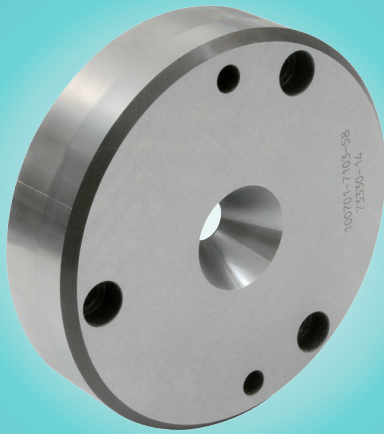

Clamping cone

Machining accessories, clamping cone

For clamping and centring rotationally symmetric work pieces.

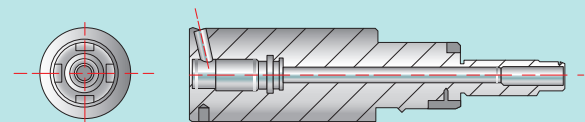
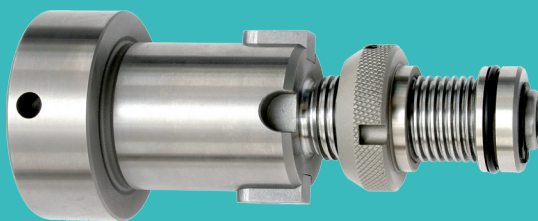

Tool holder

Machining accessories, tool holder

Clamping / anchoring the tools.

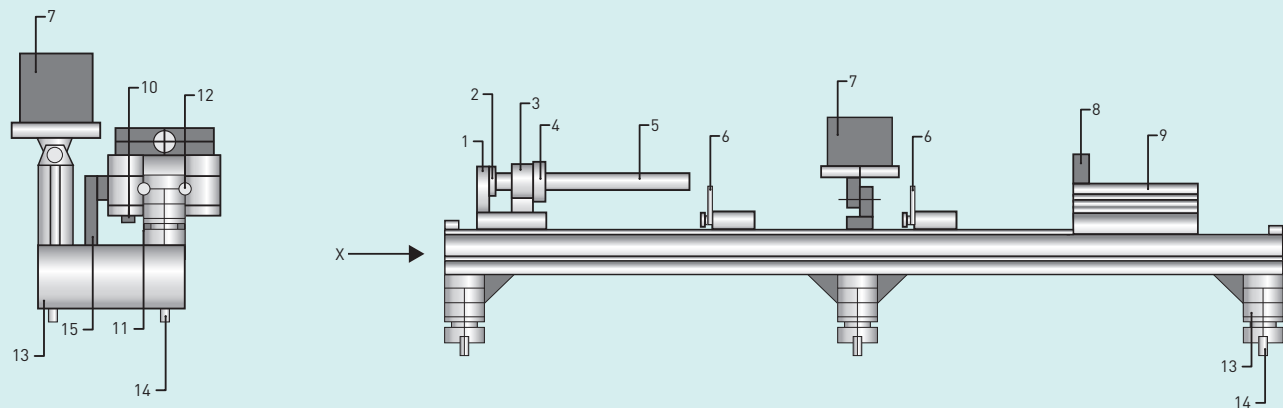

General view of length measuring device

MACHINING ACCESSORIES, TOOL SETTING DEVICE

The length measuring device is a precision instrument for setting the drill length. The above illustration shows the length measuring device and its components.

The adaptor (4) holds the plug gauge and the drill to be measured. In the case of greater lengths, the drills are supported by the sliding V-blocks which are height-adjustable and can be locked.

The sliding carrier plate (9) with mounted magnetic sensor determines the zero point and measures the length. The measurement is displayed at the position indicator (7). The incline of the position indicator is adjustable and can be adapted to the lighting conditions and the height of the operator.

The cable connecting the magnetic sensor to the position indicator is enclosed in a cable drag chain (15).

The measuring length can be extended by moving the stop plate (8) to the end of the sliding carrier plate (9).

While we supply different versions of the length measuring device, the description and operation of the devices are essentially the same.

- » table-top version
- » stand-alone version with base, drill support and plastic boxes for small parts

- 1 Base holder
- 2 Support bolt
- 3 Holder for adaptor
- 4 Adaptor
- 5 Plug gauge
- 6 V-blocks
- 7 Position indicator
- 8 Stop plate
- 9 Moving carrier plate
- 10 Magnetic sensor
- 11 Magnetic tape
- 12 Linear guide
- 13 Supports
- 14 Fastening screws
- 15 Cable drag chain



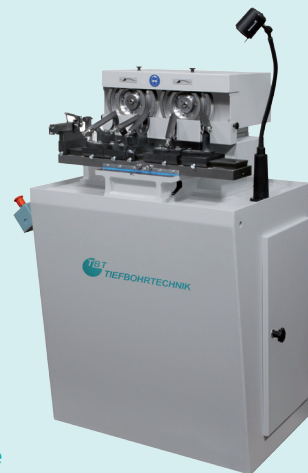

Tandem grinding machine



Universal grinding machine

Grinding machine

Our wide variety of re-sharpening devices enables you to regrind your single-lip drills yourself. Our many years of experience in this field have informed the design and manufacture of our grinding machines, devices and associated accessories.

Tandem grinding machine

A high-precision, double-spindle grinding machine designed for precision re-sharpening of larger-series single-lip drills with the same cutting edge geometry and a diameter range of 2.0 mm to approx. 20 mm.

Up to five different tool positions allow for all angles required for five-facet grinding to be re-set, making grinding even simpler. The lateral oscillation of the spindle unit is electromechanical.

- » Cutting edge geometry only has to be set once
- » Fully replaceable adaptor for different geometries and for setting the geometries
- » Eight different tool holder cassettes cover the entire range of tool diameters

A further accessory available is the dry dust extractor for efficient removal of any grinding dust in the work area.

TBT Universal clamping device

Our universal clamping device can be used on all conventional tool grinding machines. The benefits of the clamping device used on our TBT universal grinding machine speak for themselves:

- » Compact device, adjustable in three axes for grinding of all standard geometries for single-lip drills

- » Device for supporting particularly long single-lip drills
- » Two different clamping ranges [2.5 – 32 mm and 5.0 – 45 mm] cover a broad spectrum of tool diameters

In addition, our TBT universal clamping device can be fitted with a grinder holder with integrated lighting and 20x measurement microscope, for optimum re-sharpening of your very small single-lip drills (1.0 – 3.5 mm).

TBT universal grinding machine

A ready-to-operate machine for your specific requirements: the grinding spindle unit and our tried-and-tested TBT universal clamping device are mounted together on a solid plate, allowing for optimum regrinding quality for excellent drill results. A matching base and extraction unit are also available.

REFERENCE VALUES FOR DEEP HOLE DRILLING OF VARIOUS MATERIALS FOR SOLID CARBIDE SINGLE-LIP DRILLS

Material groups	Spring steels, hardened steels, high-temperature steels, cast steel / chilled cast iron, Special alloys, e.g. Nimonic, Inconel, titanium, titanium alloys		Stainless, acid-resistant steel + cast steel, austenitic 18 – 25% Cr, Ni > 8%		Stainless steel + cast steel, martensitic / ferritic 13 – 25% (sulphurated) "good machinability"		Alloyed tempered steels, case-hardened steels, nitriding steels, tool steels, (> 900N/mm ²)	
	25 – 60		30 – 60		40 – 70		60 – 80	
Cutting speed in m/min								
Drill Ø in mm	Feed mm/rev.							
	from	to	from	to	from	to	from	to
0,7 – 0,79	0,0004	0,0012	0,0005	0,0012	0,0007	0,0012	0,0005	0,0012
0,8 – 0,89	0,0006	0,0016	0,0007	0,0014	0,0011	0,0014	0,0006	0,0015
0,9 – 0,99	0,0009	0,0020	0,0011	0,0019	0,0014	0,0017	0,0009	0,0019
1,0 – 1,09	0,0013	0,0024	0,0014	0,0022	0,0019	0,0022	0,0010	0,0023
1,1 – 1,19	0,0017	0,0028	0,0017	0,0025	0,0022	0,0026	0,0013	0,0029
1,2 – 1,29	0,0020	0,0033	0,0020	0,0027	0,0024	0,0028	0,0015	0,0035
1,3 – 1,39	0,0023	0,0036	0,0022	0,0029	0,0031	0,0035	0,0020	0,0041
1,4 – 1,49	0,0026	0,0038	0,0023	0,0031	0,0034	0,0037	0,0021	0,0047
1,5 – 1,59	0,0029	0,0042	0,0024	0,0035	0,0035	0,0042	0,0021	0,0051
1,6 – 1,79	0,0035	0,0054	0,0036	0,0049	0,0040	0,0051	0,0024	0,0066
1,8 – 1,99	0,0040	0,0065	0,0040	0,0065	0,0050	0,0065	0,0030	0,0075
2,0 – 2,49	0,0050	0,0075	0,0050	0,0075	0,0050	0,0075	0,0030	0,0095
2,5 – 2,99	0,0060	0,0095	0,0060	0,0095	0,0060	0,0110	0,0040	0,0110
3,0 – 3,49	0,0080	0,0110	0,0080	0,0110	0,0080	0,0130	0,0050	0,0140
3,5 – 3,99	0,0090	0,0125	0,0100	0,0160	0,0090	0,0160	0,0070	0,0160
4,0 – 4,49	0,0100	0,0135	0,0110	0,0180	0,0100	0,0190	0,0080	0,0190
4,5 – 4,99	0,0110	0,0160	0,0140	0,0220	0,0110	0,0220	0,0110	0,0210
5,0 – 5,99	0,0130	0,0220	0,0150	0,0240	0,0130	0,0250	0,0120	0,0250
6,0 – 7,99	0,0150	0,0290	0,0180	0,0290	0,0150	0,0370	0,0150	0,0330
8,0 – 12,0	0,0170	0,0360	0,0210	0,0330	0,0170	0,0410	0,0180	0,0380

Cutting speed and feed levels depend on: tool length, cooling lubricant, material and the stability of the machine elements and work piece clamping. All values are reference values.

REFERENCE VALUES FOR DEEP HOLE DRILLING OF VARIOUS MATERIALS FOR SOLID CARBIDE SINGLE-LIP DRILLS

Material groups	Cast iron, grey cast iron (> 300 N/mm ²), ductile cast iron (> 400 N/mm ²), general steel casting		Cast iron, grey cast iron (< 300 N/mm ²), ductile cast iron (< 400 N/mm ²), malleable cast iron, white-heart malleable iron, blackheart malleable iron, "good machinability"		Non-alloy and low-alloy structural steel, machining steel, tempered steel, case hardened steel, tool steel (< 900N/mm ²), "good machinability"		Copper, bronze, brass, plastics		Aluminium + cast aluminium Si content > 5%, "good machinability"		Aluminium + aluminium alloy Si content < 5%, "not hardened"	
Cutting speed in m/min	60 – 90		70 – 100		70 – 100		80 – 150		80 – 160		100 – 300	
Drill Ø in mm	Feed mm/rev.											
	from	to	from	to	from	to	from	to	from	to	from	to
0,7 – 0,79	0,0009	0,0014	0,0007	0,0018	0,0004	0,0018	0,0005	0,0012	0,0007	0,0012	0,0005	0,0009
0,8 – 0,89	0,0012	0,0018	0,0010	0,0023	0,0004	0,0022	0,0008	0,0015	0,0012	0,0014	0,0008	0,0012
0,9 – 0,99	0,0015	0,0024	0,0014	0,0028	0,0007	0,0026	0,0011	0,0019	0,0017	0,0020	0,0011	0,0017
1,0 – 1,09	0,0019	0,0029	0,0018	0,0032	0,0010	0,0032	0,0015	0,0024	0,0020	0,0024	0,0015	0,0024
1,1 – 1,19	0,0025	0,0035	0,0022	0,0038	0,0014	0,0038	0,0019	0,0029	0,0022	0,0029	0,0019	0,0034
1,2 – 1,29	0,0031	0,0041	0,0030	0,0048	0,0018	0,0041	0,0024	0,0034	0,0024	0,0034	0,0024	0,0041
1,3 – 1,39	0,0040	0,0051	0,0039	0,0060	0,0020	0,0050	0,0028	0,0039	0,0026	0,0045	0,0026	0,0044
1,4 – 1,49	0,0047	0,0060	0,0049	0,0079	0,0021	0,0054	0,0031	0,0047	0,0028	0,0055	0,0032	0,0048
1,5 – 1,59	0,0053	0,0068	0,0056	0,0100	0,0021	0,0067	0,0032	0,0053	0,0035	0,0066	0,0038	0,0059
1,6 – 1,79	0,0064	0,0095	0,0064	0,0150	0,0028	0,0075	0,0035	0,0095	0,0040	0,0085	0,0040	0,0075
1,8 – 1,99	0,0070	0,0130	0,0070	0,0220	0,0030	0,0095	0,0040	0,0130	0,0050	0,0110	0,0050	0,0110
2,0 – 2,49	0,0100	0,0220	0,0090	0,0330	0,0040	0,0120	0,0040	0,0180	0,0050	0,0200	0,0070	0,0130
2,5 – 2,99	0,0130	0,0320	0,0110	0,0430	0,0050	0,0160	0,0050	0,0250	0,0060	0,0360	0,0080	0,0170
3,0 – 3,49	0,0150	0,0390	0,0140	0,0530	0,0080	0,0180	0,0060	0,0370	0,0080	0,0540	0,0100	0,0200
3,5 – 3,99	0,0180	0,0480	0,0180	0,0620	0,0090	0,0230	0,0070	0,0490	0,0110	0,0750	0,0100	0,0250
4,0 – 4,49	0,0200	0,0560	0,0200	0,0690	0,0120	0,0260	0,0080	0,0600	0,0120	0,0950	0,0130	0,0300
4,5 – 4,99	0,0230	0,0640	0,0230	0,0780	0,0140	0,0280	0,0090	0,0690	0,0140	0,1300	0,0160	0,0360
5,0 – 5,99	0,0250	0,0760	0,0250	0,0950	0,0150	0,0380	0,0100	0,0800	0,0150	0,1550	0,0200	0,0470
6,0 – 7,99	0,0300	0,1100	0,0300	0,1250	0,0180	0,0490	0,0120	0,0960	0,0180	0,2050	0,0260	0,0660
8,0 – 12,0	0,0330	0,1190	0,0350	0,1360	0,0210	0,0570	0,0140	0,1100	0,0210	0,2080	0,0290	0,0780

Cutting speed and feed levels depend on: tool length, cooling lubricant, material and the stability of the machine elements and work piece clamping. All values are reference values.

CUTTING DATA

REFERENCE VALUES FOR DEEP HOLE DRILLING OF VARIOUS MATERIALS FOR SINGLE-LIP DRILLS WITH BRAZED-ON CARBIDE HEAD

Material groups	Spring steels, hardened steels, high-temperature steels, cast steel / chilled cast iron , Special alloys, e.g. Nimonic, Inconel, titanium, titanium alloys		Stainless, acid-resistant steel + cast steel, austenitic 18 – 25% Cr, Ni > 8%		Stainless steel + cast steel, martensitic / ferritic 13 – 25% (sulphurated) "easily machinable"		Alloyed tempered steels, case-hardened steels, nitriding steels, tool steels, (> 900N / mm ²)	
	25 – 60		30 – 60		40 – 70		60 – 80	
Cutting speed in m/min								
Drill Ø in mm	Feed mm/rev.							
	from	to	from	to	from	to	from	to
1,9 – 2,49	0,001	0,002	0,002	0,005	0,002	0,006	0,002	0,005
2,5 – 2,99	0,001	0,005	0,004	0,007	0,004	0,007	0,004	0,006
3,0 – 3,49	0,002	0,007	0,006	0,008	0,005	0,009	0,005	0,007
3,5 – 3,99	0,004	0,008	0,008	0,009	0,007	0,011	0,007	0,010
4,0 – 4,49	0,006	0,009	0,009	0,010	0,008	0,013	0,008	0,012
4,5 – 4,99	0,008	0,011	0,010	0,013	0,009	0,017	0,011	0,015
5,0 – 5,99	0,010	0,014	0,012	0,015	0,013	0,019	0,013	0,018
6,0 – 6,99	0,012	0,016	0,014	0,017	0,015	0,023	0,015	0,022
7,0 – 7,99	0,015	0,018	0,016	0,019	0,018	0,026	0,018	0,025
8,0 – 8,99	0,018	0,021	0,018	0,021	0,020	0,031	0,020	0,027
9,0 – 9,99	0,021	0,025	0,020	0,028	0,023	0,034	0,023	0,030
10,0 – 11,99	0,024	0,030	0,025	0,033	0,025	0,041	0,025	0,038
12,0 – 13,99	0,027	0,033	0,030	0,038	0,030	0,045	0,029	0,044
14,0 – 15,99	0,029	0,040	0,035	0,044	0,035	0,052	0,035	0,050
16,0 – 17,99	0,033	0,044	0,041	0,050	0,042	0,060	0,039	0,053
18,0 – 19,99	0,037	0,049	0,045	0,062	0,045	0,067	0,044	0,060
20,0 – 23,99	0,041	0,054	0,049	0,071	0,050	0,079	0,049	0,069
24,0 – 27,99	0,045	0,057	0,052	0,083	0,054	0,090	0,054	0,077
28,0 – 31,99	0,049	0,062	0,057	0,091	0,059	0,098	0,059	0,085
32 – 39,99	0,052	0,065	0,063	0,098	0,065	0,107	0,063	0,098
40 – 50	0,055	0,069	0,068	0,105	0,071	0,113	0,068	0,105

Cutting speed and feed levels depend on: tool length, cooling lubricant, material and the stability of the machine elements and work piece clamping. All values are reference values.

REFERENCE VALUES FOR DEEP HOLE DRILLING OF VARIOUS MATERIALS FOR SINGLE-LIP DRILLS WITH BRAZED-ON CARBIDE HEAD

Material groups	Cast iron, grey cast iron (> 300 N/mm ²), ductile cast iron (> 400 N/mm ²), general steel casting		Cast iron, grey cast iron (< 300 N/mm ²), ductile cast iron (< 400 N/mm ²), malleable cast iron, whiteheart malleable iron, blackheart malleable iron, "good machinability"		Non-alloy and low-alloy structural steel, machining steel, tempered steel, case hardened steel, tool steel (< 900N/mm ²), "good machinability"		Copper, bronze, brass, plastics		Aluminium + cast aluminium Si content > 5%, "good machinability"		Aluminium + aluminium alloy Si content < 5%, "not hardened"	
	60 – 90		70 – 100		70 – 100		80 – 150		80 – 160		100 – 300	
Cutting speed in m/min	60 – 90		70 – 100		70 – 100		80 – 150		80 – 160		100 – 300	
Drill Ø in mm	Feed mm/rev.											
	from	to	from	to	from	to	from	to	from	to	from	to
1,9 – 2,49	0,005	0,018	0,005	0,019	0,003	0,007	0,003	0,015	0,002	0,012	0,002	0,005
2,5 – 2,99	0,008	0,028	0,008	0,026	0,005	0,010	0,005	0,020	0,004	0,026	0,004	0,008
3,0 – 3,49	0,009	0,038	0,009	0,038	0,007	0,013	0,006	0,030	0,006	0,037	0,006	0,012
3,5 – 3,99	0,011	0,042	0,011	0,046	0,009	0,015	0,007	0,045	0,007	0,055	0,007	0,025
4,0 – 4,49	0,012	0,047	0,012	0,050	0,012	0,019	0,008	0,050	0,008	0,071	0,008	0,026
4,5 – 4,99	0,016	0,052	0,016	0,057	0,014	0,020	0,009	0,057	0,009	0,094	0,009	0,028
5,0 – 5,99	0,018	0,065	0,018	0,068	0,016	0,026	0,010	0,069	0,010	0,109	0,010	0,036
6,0 – 6,99	0,024	0,071	0,024	0,074	0,018	0,028	0,012	0,079	0,012	0,125	0,012	0,045
7,0 – 7,99	0,028	0,084	0,028	0,085	0,021	0,035	0,014	0,092	0,018	0,130	0,014	0,049
8,0 – 8,99	0,032	0,092	0,032	0,096	0,024	0,036	0,016	0,101	0,020	0,144	0,016	0,056
9,0 – 9,99	0,036	0,110	0,036	0,114	0,027	0,040	0,018	0,113	0,023	0,158	0,018	0,064
10,0 – 11,99	0,045	0,116	0,050	0,120	0,030	0,049	0,020	0,139	0,025	0,174	0,020	0,074
12,0 – 13,99	0,051	0,126	0,060	0,138	0,036	0,060	0,024	0,156	0,030	0,182	0,024	0,087
14,0 – 15,99	0,057	0,138	0,070	0,154	0,042	0,071	0,028	0,179	0,035	0,194	0,028	0,099
16,0 – 17,99	0,062	0,158	0,079	0,170	0,048	0,079	0,033	0,199	0,050	0,209	0,033	0,108
18,0 – 19,99	0,066	0,173	0,090	0,191	0,054	0,091	0,036	0,224	0,054	0,228	0,036	0,130
20,0 – 23,99	0,069	0,189	0,106	0,207	0,060	0,107	0,040	0,249	0,060	0,254	0,040	0,146
24,0 – 27,99	0,076	0,210	0,120	0,221	0,069	0,117	0,048	0,291	0,072	0,295	0,048	0,169
28,0 – 31,99	0,079	0,212	0,140	0,237	0,079	0,134	0,056	0,327	0,084	0,360	0,056	0,194
32 – 39,99	0,086	0,228	0,160	0,245	0,085	0,154	0,064	0,380	0,096	0,455	0,064	0,221
40 – 50	0,089	0,239	0,180	0,254	0,091	0,169	0,072	0,399	0,105	0,488	0,072	0,239

Cutting speed and feed levels depend on: tool length, cooling lubricant, material and the stability of the machine elements and work piece clamping. All values are reference values.

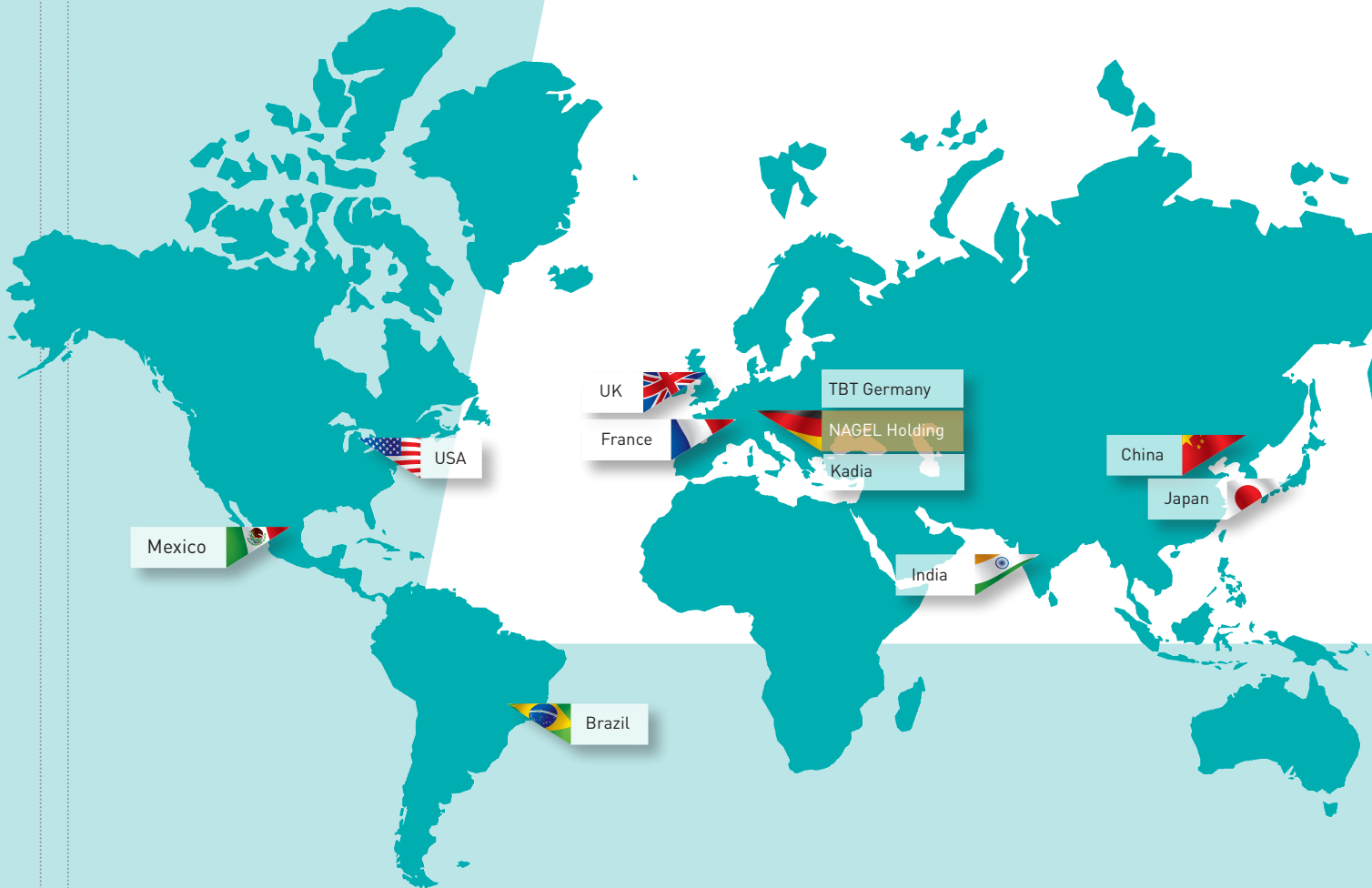

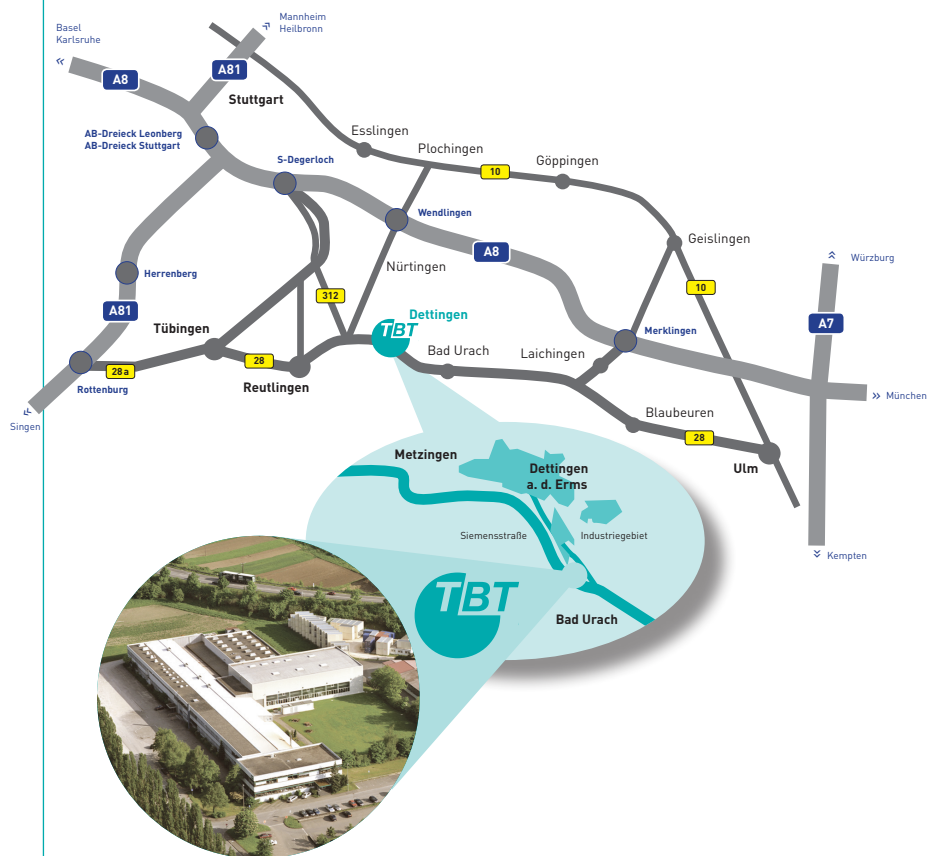

TBT Tiefbohrtechnik GmbH + Co

Siemensstraße 1
72581 Dettingen a.d. Erms
Germany

Phone: +49 (0) 7123 / 976-0
Fax: +49 (0) 7123 / 976-200
E-mail: info@tbt.de
Web: www.tbt.de

TBT China

Shanghai Office

Gonghe Xin Lu 3699 Block A 1511,
Zha Bei District
Shanghai 200070, China
E-Mail: info@tbtchina.cn

Wuxi Factory

Cheng Nan Rd 212, New District
Wuxi 214028, Jiangsu, China
E-Mail: info@tbtchina.cn

Nagel Precision

288 Dino Drive
Ann Arbor, MI 48103
USA
Phone: +1 734 426 5650
Fax: +1 734 426 5649
E-Mail: tbtodrills@nagelusa.com

TBT UK Limited

Gorsey Lane
Coleshill
Birmingham, B46 1JU, England
Phone: +44 1675 433250
Fax: +44 1675 433260
E-Mail: info@tbtuk.com

TBT France

Zone Industrielle
Rue Joseph Cugnot
F-57200 Sarreguemines, Frankreich
Phone: +33 387 983318
Fax: +33 387 984932
E-Mail: contact@tbt.fr